

**Intellian<sup>®</sup>**

**FB250 / FB500**

**Installation and Operation User Manual**

## Serial number of the product

--

This serial number will be required for the all troubleshooting or service inquiries.

# Intellian<sup>®</sup>

© 2013 Intellian Technologies Inc. All rights reserved. Intellian and the Intellian logo are trademarks of Intellian Technologies, Inc., registered in the U.S. and other countries. All other logos, trademarks, and registered trademarks are the property of their respective owners. Information in this document is subject to change without notice. Every effort has been made to ensure that the information in this manual is accurate. Intellian is not responsible for printing or clerical errors.

---

<b>REGULATORY INFORMATION</b>	<b>4</b>
<b>INTRODUCTION</b>	<b>6</b>
<b>OVERVIEW OF THE FLEETBRODBAND SYSTEM</b>	<b>8</b>
<b>MAIN UNITS</b>	<b>9</b>
<b>INSTALLATION</b>	<b>14</b>
Installation of ADU	15
Installation of BDU	19
Installation of Primary Handset	21
Connections	22
<b>GETTING STARTED</b>	<b>26</b>
System configuration	26
Preparation for Operation	27
<b>USING THE PRIMARY HANDSET</b>	<b>31</b>
<b>USING THE WEB CONSOLE</b>	<b>65</b>
<b>TROUBLESHOOTING</b>	<b>122</b>
<b>TECHNICAL SPECIFICATION</b>	<b>128</b>

---

## **REGULATORY INFORMATION**

### **FEDERAL COMMUNICATION COMMISSION NOTICE**

**FCC Identifier: QO4-AVIFB500BDE / QO4-AVIFB250BDE**

#### **USE CONDITIONS:**

This device complies with part 15 of the FCC Rules. Operation is subject to the following two Conditions:

1. This device may not cause harmful interference, and
2. This device must accept any interference received, including interference that may cause undesired operation.

#### **NOTE:**

This equipment has been tested and found to comply with the limits for a Class B digital device, pursuant to Part 15 of the FCC Rules. These limits are designed to provide reasonable protection against harmful interference in a residential installation. This equipment generates uses and can radiate radio frequency energy and, if not installed and used in accordance with the instructions, may cause harmful interference to radio communications. However, there is no guarantee that interference will not occur in a particular installation.

If this equipment does cause harmful interference to radio or television reception, which can be determined by turning the equipment off and on, the user is encouraged to try to correct the interference by one of the following measures:

- Reorient or relocate the receiving antenna.
- Increase the separation between the equipment and receiver.
- Connect the equipment into an outlet on a circuit different from that to which the receiver is connected.
- Consult the dealer or an experienced radio/TV technician for help.

#### **IMPORTANT NOTE: EXPOSURE TO RADIO FREQUENCY RADIATION**

This Device complies with FCC & IC radiation exposure limits set forth for an uncontrolled environment. The Antenna used for this transmitter must be installed to provide a separation distance of at least 100cm from all persons and must not be co-located or operating in conjunction with any other antenna or transmitter.

#### **FCC CAUTION:**

Any Changes or modifications not expressly approved by the manufacturer could void the user's authority, which is granted by FCC, to operate this satellite Fleet-Broadband System FB250 / FB500.

---

## **INDUSTRY CANADA STATEMENT:**

### **IC: 5023B-AVIFB500BDE / IC: 5023B-AVIFB250BDE**

This device complies with Radio standard specification RSS -170 of Industry Canada Rules. Operation is subject to the following two conditions:

1. This device may not cause harmful interference, and
2. This device must accept any interference received, including interference that may cause undesired operation.

### **IMPORTANT NOTE: Radiation Exposure Statement**

This equipment complies with IC radiation exposure limits set forth for an uncontrolled environment. This antenna used for this transmitter must be installed to provide a separation distance of at least 100cm from all persons and must not be co-located or operating in conjunction with any other antenna or transmitter.

### **EC Declaration of Conformity:**

Intellian Technologies, Inc., 348-5 Chungho-ri, Jinwi-myeon, Pyeongtaek-Si, Gyeonggi-do, Korea 451- 862 declares

under our sole responsibility that the accessory Product, brand name as Intellian and models:

FB250 / FB500 FleetBroadband satellite communication system, to which this declaration relates, is in conformity with the following standards and/or other normative documents:

RoHS2 Directive 2011/65/EU

ETSI EN 301 444, ETSI EN 301 489-1, -17,-19 & -20, ETSI EN 300 328 IEC 60945 / EN 60945,

IEC 60950-1 AND EN 60950-1, ITU-R M.1480

We hereby declare that all essential radio test suite have been carried out and that the above named product is in conformity to all the essential requirements of Directive 1999/5/EC.

The Conformity Assessment procedure referred to Article 10 and detailed in Annex [III] or [IV] of Directive 1999/5/EC has been followed with involvement of the following notified body (ies):

**TIMCO ENGINEERING Inc., P.O BOX 370, NEWBERRY, FLORIDA 32669. Identification mark: 1177 (Notified Body number)**

## 1. INTRODUCTION

The Intellian FB250 / FB500 User Equipment is a dedicated compact solution specifically designed to meet the FleetBroadband ( FBB ) services for the maritime environment providing seamless ocean coverage from 76° North to 76° South. FBB is the marine version of the highly successful BGAN (Broadband Global Area Network) from Inmarsat.

Through a maritime BGAN antenna, it provides constant, simultaneous access to voice and high-speed data in a compact solution. Allowing you to run online operation systems, and still having access to email, intranet and voice calls - achieving greater operational efficiencies and significantly reducing the cost of both business and crew communications.



### 1.1 Range of Service

- Email and webmail
- Secure communications
- Intranet and internet access
- SMS and instant messaging Videoconferencing and streaming  
Phoneand fax services
- Large file transfers

---

## 1.2 Features

The FB250/500 offers the following features

Service	FB250	FB500
<b>Coverage</b>	Voice, fax and data are available globally except for the extreme polar regions	
<b>Voice</b>	4kbps AMBE + 2 3.1KHz Audio (above 20° elevation)	4kbps AMBE + 2 3.1KHz Audio (above 5° elevation)
<b>Fax</b>	Group 3 fax via 3.1KHz Audio (above 20° elevation)	Group 3 fax via 3.1KHz Audio. (above 5° elevation)
<b>SMS</b>	Standard 3G (up to 160 characters) per SMS. Maximum of 4 chained SMS.	
<b>Data</b>	Standard IP : Up to 284 kbps Streaming IP : 8, 16, 32, 64, 128 kbps	Standard IP : Up to 432 kbps Streaming IP : 8, 16, 32, 64, 128, 256 kbps

The UE has built-in Web Console, allowing you to manage your phone book, messages and calls, and customize the terminal to your specific needs.

## 1.3 Interfaces

The FB250/500 UE has the following connecting interfaces:

- +12V / 24V DC Power Input Connector
- Antenna Connector ( TNC-Type )
- SIM Card Slot for FBB SIM card
- Dedicated Primary Handset port
- I/O Port
- GPS Output Port

The number of RJ45 Ethernet ports and RJ11 ports for the BDUs of the FB250 and FB500 is illustrated below:

RJ45 Ethernet Ports for PC and router	4 LAN Ports (including 2 PoE)
<b>RJ11 Phone</b>	Yes
<b>RJ11 Fax</b>	Yes
<b>Built-in WiFi</b>	Yes

## 2. OVERVIEW OF THE FLEETBROADBAND SYSTEM

### BGAN Services

The Broadband Global Area Network (BGAN) is a global Satellite Internet Network using portable terminals. The terminals are usually connected to a laptop computer to access broadband Internet in remote locations, where a line-of-sight to the satellite exists. The user can make phone calls, access the Internet, check e-mail, download files, or perform any other Internet activity using the terminals. The network is provided by Inmarsat and uses three geostationary satellites called I-4 to provide almost global coverage.

The map below shows the three I-4 satellite coverage regions.

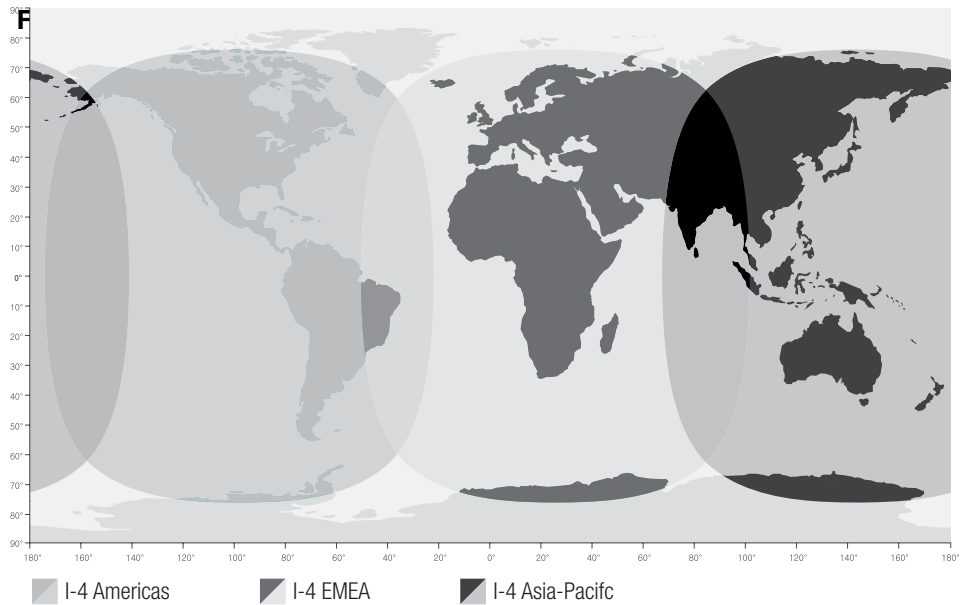

This map depicts Inmarsat's expectations of coverage, but does not represent a guarantee of service. The availability of service at the edge of coverage areas fluctuates depending on various conditions.

**Note:** The above map depicts Inmarsat's expectations of coverage, but does not represent a guarantee of service. The availability of service at the edge of coverage areas fluctuates depending on various conditions.



---

### 3. MAIN UNITS

The FB250/500 FleetBroadband system include the following main units:

#### FB250

- FB250 FleetBroadband BDU
- FB250 FleetBroadband ADU
- Primary Handset

#### FB500

- FB500 FleetBroadband BDU
- FB500 FleetBroadband ADU
- Primary Handset

#### 3.1 Above Deck Unit (ADU), the antenna unit

The FB series ADU is Maritime FleetBroadband 3-axis controlled antenna. The antenna is self-tracking based on patented beam squint technology. The simple and robust electromechanical system, with one motor per free axis, provides full coverage in azimuth and elevation. Tracking is accomplished by measuring signals being continuously broadcast from the satellite.

The radome covers the antenna equipments, which is composed of:

- Antenna Unit
- RF and GPS circuit
- Rotary joint
- Antenna pedestal

The antenna unit includes LNA (low noise amplifier), HPA (high power amplifier) and tracking receiver circuitry to ensure communication even in adverse circumstances.



All signals (and DC power) shall pass through a single coaxial antenna cable, which connects the ADU to the BDU.

### 3.2 Below Deck Unit (BDU)

The BDU has been developed for maximum flexibility and is the controlling unit for the FBB UE. It features a reliable industry standard interfacing field and enables users to have optimal connectivity no matter what the conditions or your position at sea.



The BDU has a built-in Web Console, which can be accessed from a computer connected to the BDU, using an Internet browser. The Web Console provides easy configuration of the BDU, firmware upgrade and daily use. For more information, see Chapter 4, using the Web Console.

The BDU is supplied by a +12V or +24V DC power supply, and it supplies power to the ADU via a single RF/coaxial antenna cable.

---

### Status LEDs



There are 3 Status LEDs to indicate the operational status of the BDU at one glance.

Each LED is assigned to the following function:

- BDU Terminal Status
- ADU Status
- Registered to Network Status

### SIM Card Slot



The BDU has a SIM (Subscriber Identity Module) card slot located at the connector panel behind a small cover plate. The UE requires a dedicated FBB SIM card to access the FBB network and configure the settings of the UE.

### Front panel

The following diagram shows the front panel of the BDU.

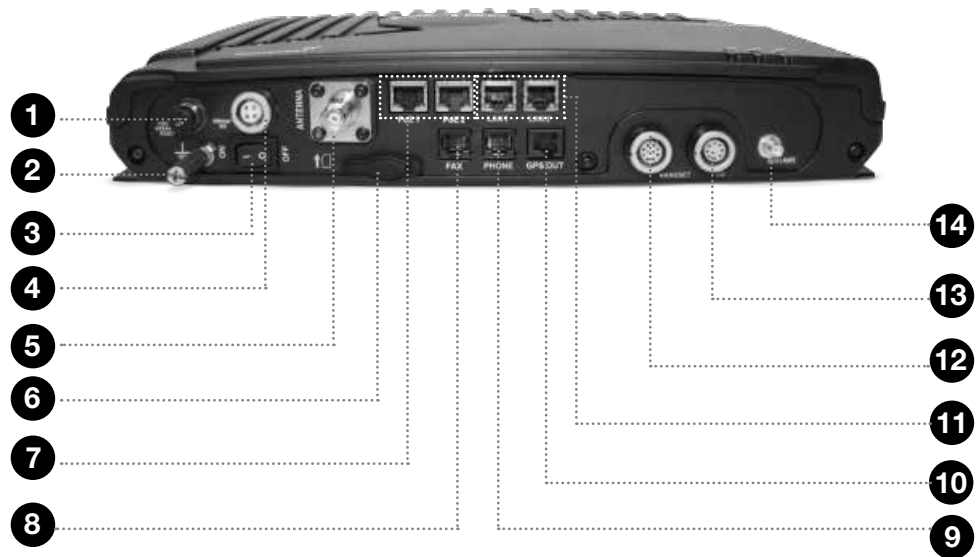

- 1. Resettable Circuit Breaker
- 2. Grounding Stud
- 3. Power Switch
- 4. DC Power Connector
- 5. Antenna (TNC-Type) Connector
- 6. SIM Card Slot
- 7. PoE Ports (RJ45)
- 8. Fax Port (RJ11)
- 9. Phone Port (RJ11)
- 10. GPS Output Port
- 11. LAN Ports (RJ45)
- 12. Primary Handset Port
- 13. GPIO Port
- 14. WiFi Connector

---

### 3.3 Primary Handset



The wired Primary Handset has a colour LCD and keypad for making and receiving voice calls and sending SMS using an interface similar with a mobile phone. It can serve as a remote access for user to access various BDU functions. The Primary Handset connector is plugged into the BDU primary handset port and it is powered directly from the BDU.

## 4. INSTALLATION

### 4.1. USER EQUIPMENT LISTS

#### **FB250 Complete Standard Package**

Description

- FB250 Terminal

#### **FB500 Complete Standard Package**

Description

- FB500 Terminal

#### **FB250 / FB500 Standard Accessories**

Description

- FB500 FleetBroadband Primary Handset
- FB250 FleetBroadband Primary Handset
- Ethernet Cable (1.5m)
- Telephone Cord (1.8m)
- Handset Wall Mount Cradle
- Power Cable (3m)
- GPIO Cable 8-pin (1m)

#### **FB250 / FB500 Installation Kit**

Description

- Hex. Bolt x 5 (FB250:M8x35L, FB500:M8x50L)
- Hex. head Wrench Bolt x 4 (M6x20L)
- Flat Washer x 5 (M8)
- Spring Washer x 5 (M8)
- Dome Washer x 5 (M6)

---

## 4.1 Installation of ADU

### Planning the Installation

Install the antenna in accordance with the following procedures to ensure maximum performance of the antenna. The antenna should be installed in a place where it has an all-around clear view of the horizon. Please be sure there are no obstacles within 15 degrees above the antenna. Any obstacles can prevent the antenna from tracking the satellite signal (Refer to the drawing on the right).

Do not install the antenna near by the radar especially on the same plane as their energy levels may overload the antenna front-end circuits. It is recommended to position the antenna at least 4 feet (1.2m) above or below the level of the radar and minimum of 15 feet (6m) away from the high power short wave radars. The mounting platform should be rigid enough and not subjected to excessive vibration. The movement of the antenna can be minimized by installing at the center of the vessel. For optimal performance of the antenna, it is not recommended to install at any corner of the vessel, where the movement of the vessel is the greatest. Install the bottom of the antenna parallel to the surface of the sea and fix tightly to the structure of the vessel. When setting the antenna down, be careful not to damage the RF connector. Striking the connectors on the bottom directly will damage the connector.

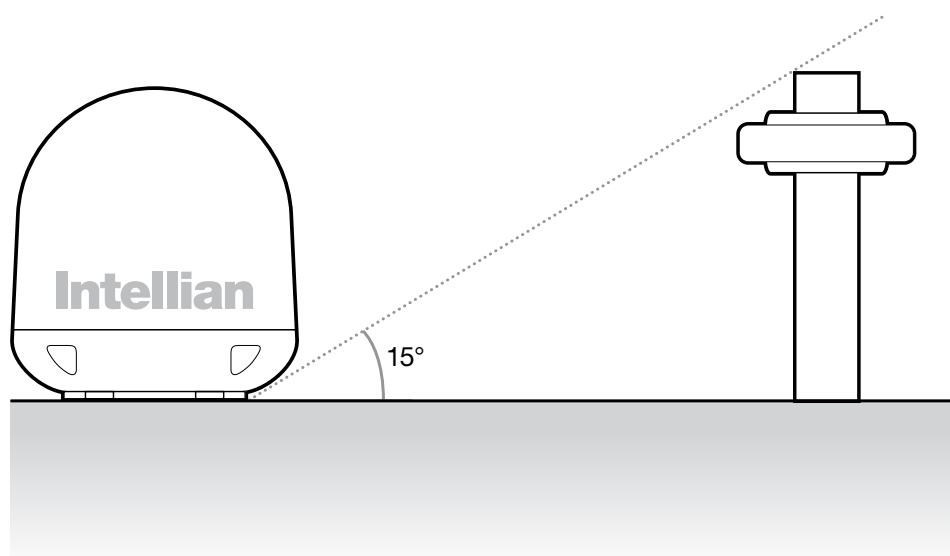

**Installation and Mounting of Antenna**

The method of installation and mounting of antenna may vary due to vessel design but the following procedures are applicable in most situations, and will result in a secure and effective installation.

**Confirmation of Size Prior to Installation**

- Check the height and diameter of the bottom surface of the antenna before installing.
- The space must be sufficient for installing the antenna unit considering the height and diameter of the antenna.
- The height and the diameter of the bottom surface of the antenna are as shown in the following drawing. If possible, install the antenna using a power tower.

**Note:** Before installing the antenna, open the radome and remove the shipping constraints from the antenna interior. Reinstall the radome before operating the system. The system will not perform properly if the radome is open.

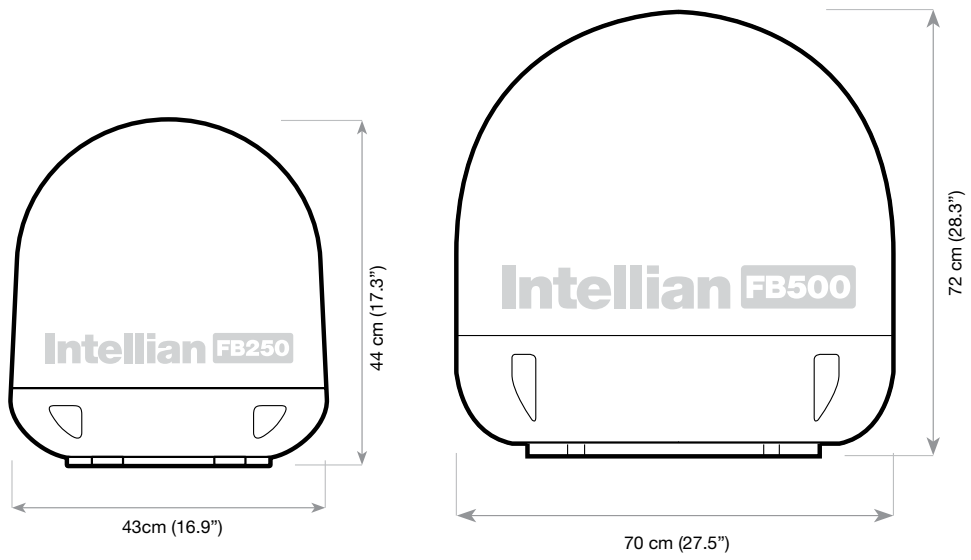

Radome Dimension of FB250

Radome Dimension of FB500



### Mark of the Antenna Mounting Position

Referring to the mounting template, mark where antenna will be mounted on board (it must be a flat surface) or on a separate power tower

**Note:** If a power tower is not suitable to mount the antenna, separate cable shock and waterproofing measures must be taken to protect the RF connector from being exposed to the sea water and external shocks. An exposed cable may cause electric shock and cause serious damage to the equipment.

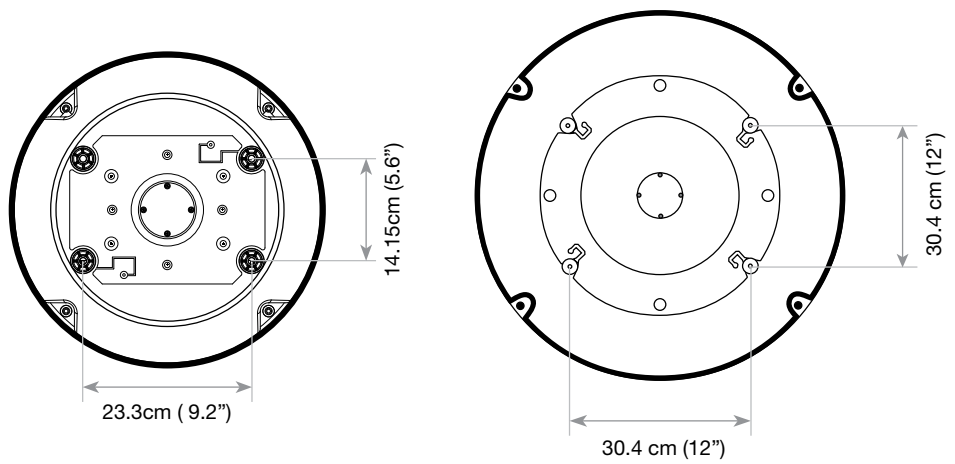

Mounting Hole position of FB250

Mounting Hole position of FB500

### Securing Holes for Bolts and Cable Ways

Make 4 bolt holes of 10mm diameter, one at corner of a rectangle drawn as below, and make a circular hole of 80mm diameter at the center of the rectangle through which the cable will run.

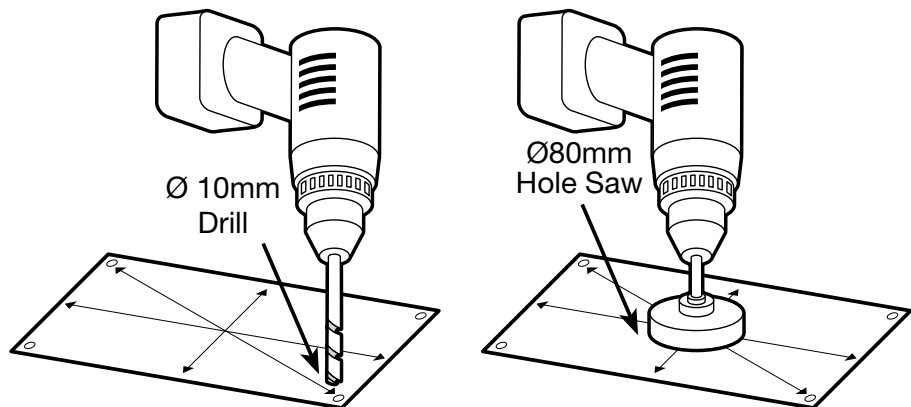

### Connection of the Cable

Remove the rubber cap from RF connector. Connect the RF cable to the RF connector under the base plate through the access hole. Be careful not to over tighten, as you may damage the connector.

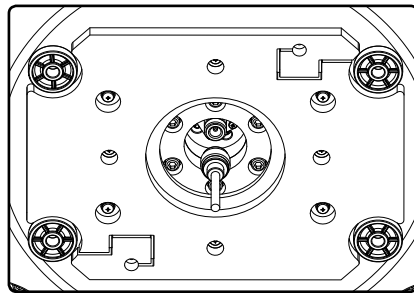

FB250

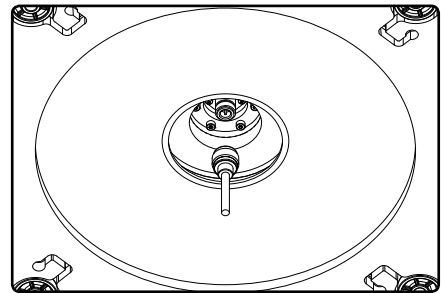

FB500

**Note:** Do not tighten excessively when using the spanner, this will damage the threads. Be careful that the connectors do not touch the mounting surface of the antenna, this might cause a critical malfunction and serious damage to the equipment.

### Mounting the Antenna

Attach the antenna by using the hex head bolts (M8X35L for FB250, M8X50L for FB500), M8 spring washers, and M8 flat washers supplied.

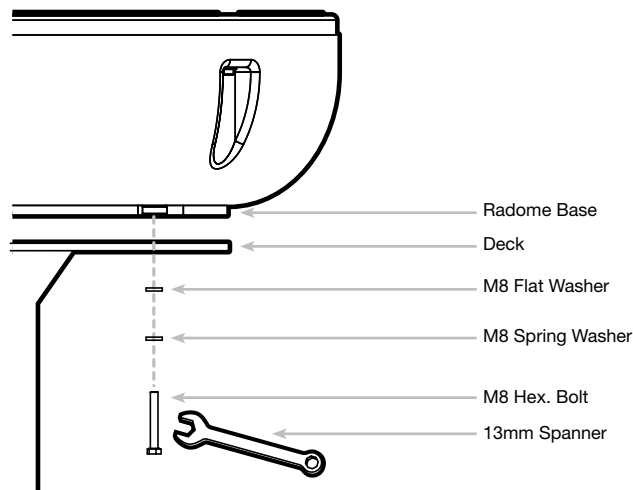

---

## 4.2 Installation of BDU

The BDU's pretty box is unpacked and the following items should be checked whether they are present:

- BDU
- 1 meter Wired Primary Handset with cradle
- 1.5 meters Ethernet Cable
- 1.8 meters Telephone Cord
- 1.8 meters DC Power Cable
- 1 meter GPIO (General Purpose Input / Output) cable

The following important notes are to be followed for the selection of a location before installing the BDU:

- The unit is not water proof and it has to be kept away from water splash.
- The ambient temperature and humidity in the selected location must the requirements given in the unit's specification.

Ambient Temperature	-25°C to +55°C
Relative Humidity	Up to 95% at +40°C

- The unit shall be kept away from direct sunlight.
- The unit shall be placed away from any high-vibrated and shock areas (for example, motor engine and generator) as far as possible.
- The unit shall be kept away from any equipment.
- The unit has to follow the recommended compass safe distance of 1m to prevent interference to a magnetic compass.
- For maintenance and checking, the unit's location has sufficient space at its sides and rear.

The BDU can be installed on a desktop, bulkhead, top ceiling or under captain's console.

The procedure of the installing the BDU is simple as follow:

- Place the BDU on the desired installation area.
- Look for the holes of the BDU's mounting brackets.



- Fix the holes of mounting brackets with four M4x12mm self-tapping or machined screws so that the BDU is being secured.

---

### 4.3 Installation of Primary Handset

The primary handset is provided with cradle. It can be mounted on a desktop, bulkhead, top ceiling or under captain's console as similar as the BDU.

The primary handset is to be separated from its cradle so that the cradle can be fixed with the M5 x 12mm self-tapping screws.

The procedure of the installing the cradle is simple as follow:

1. Separate the handset from the cradle and remove the plastic cover of the cradle.
2. Position the the cradle on the mounting areas.
3. Fix the cradle with M5 x 12mm self-tapping screws, which are supplied.
4. Reattach the plastic cover onto the cradle.
5. Secure the handset onto the cradle.

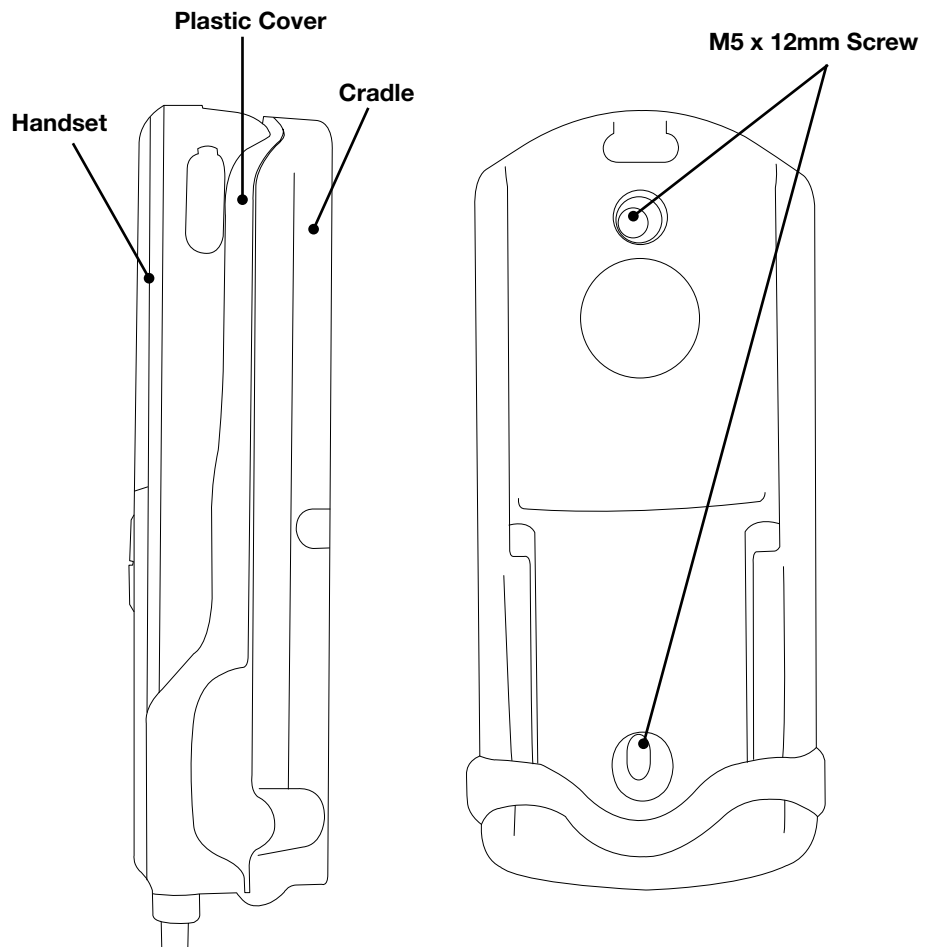

## 5. CONNECTIONS

Below is the interconnection diagram of FB UE with the cables.



### 5.1 BDU's Outputs Connection

The additional information of the output ports of GPS and GPIO.

#### GPS Output RJ11 (Offset) Connector

The BDU has a The Transceiver Unit has a GPS output RJ11 (Offset) connector for outputting the GPS data in NMEA0183 format.

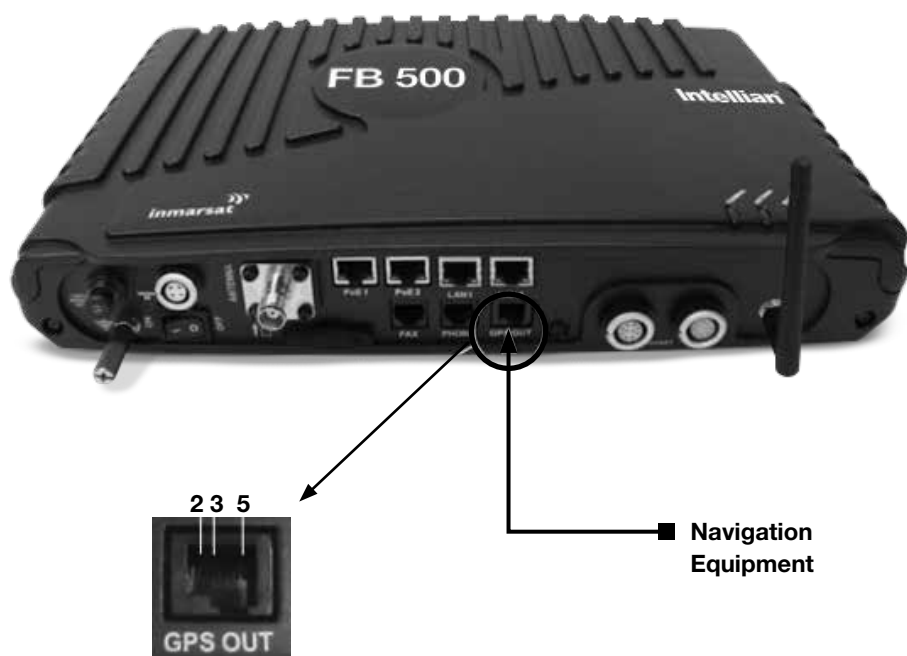

#### GPS Output Pinout

Pin No.	Signal
Pin 5	TX
Pin 2	RX
Pin 3	GND

#### RS232 Pinout

Pin No.	Signal
Pin 2	RX
Pin 3	TX
Pin 5	GND

### GPIO Output

The BDU has a dedicated circular connector to provide GPIO (General Purpose Input/Output) interface to the external devices.



### GPIO Output

GPIO Port Pin	Signal Name	Description of Signal	Color Code
GPIO-1	RES_1	Reserve line 1	Black
GPIO-2	GND	Ground line	Brown
GPIO-3	LED_ENABLE	To enable LED ON	Red
GPIO-4	REM_ON_OFF	Remote ON / OFF	Orange
GPIO-5	BUZZER	Buzzer	Yellow
GPIO-6	GND	Ground line	Green
GPIO-7	TX_OFF	To turn off Transmitter off	Blue
GPIO-8	+5V_DC	+5V DC Output with up to 100mA	Purple

All wires for the GPIO connector shall use AWG 24 unscreened wire type.

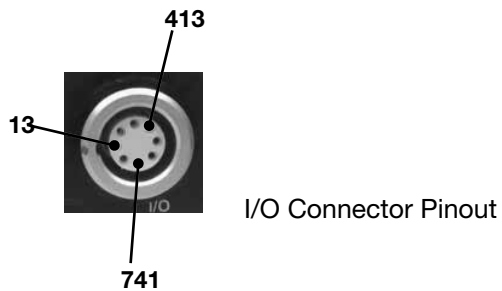



---

### **Grounding Stud**

The BDU has a grounding stud with a locking screw for the earth cable (with its colors of green and yellow) with its UE lug. It is recommended to include spring washers to secure the UE lug to the grounding stud.

## 6. GETTING STARTED

### 6.1 System Configuration

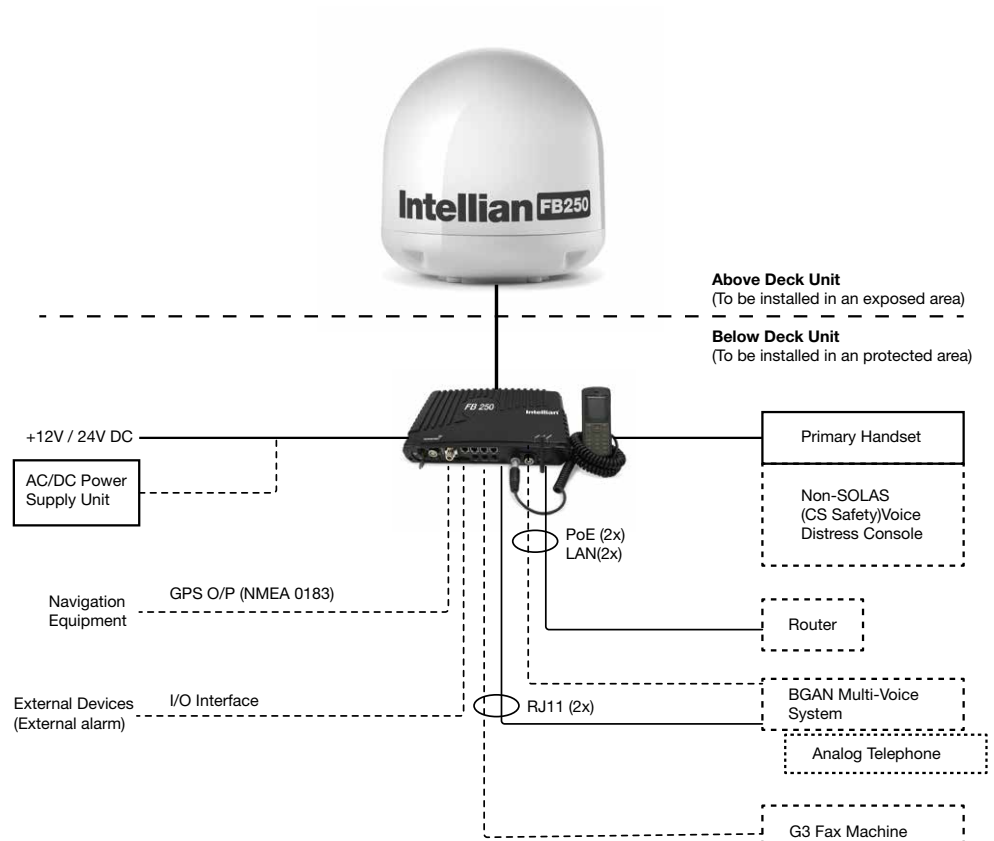

Solid line refers to the basic configuration.

---

## 6.2 Preparation for Operation

### Install the SIM card.

The system requires a SIM card to access the Inmarsat's FleetBroadband network and configure the settings of the BDU. Please refer to your Airtime Service Provider for more information.

1. Tilt up the SIM card slot rubber cover.

**Note:** Make sure the BDU is switched off before inserting or removing the SIM card.

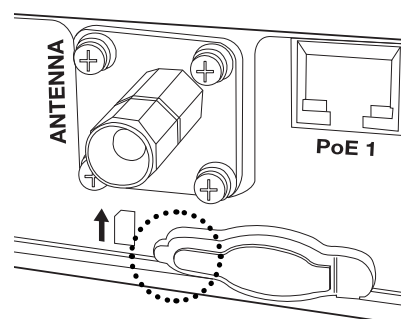

2. Position the SIM card with its gold-contacts facing down. (There is a symbol of SIM Card with its arrow on the front panel to ensure the correct orientation of the SIM Card when it is being inserted.)

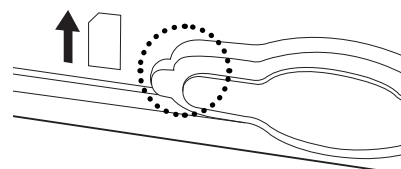

3. Push the SIM card gently until it clicks and is locked in place.

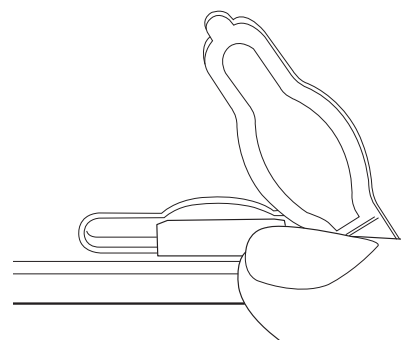

4. Tilt down the SIM card cover to its original position.

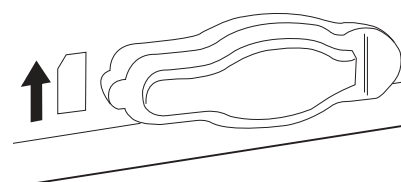

### Connecting Primary Handset

The Primary Handset is powered from the BDU through the Primary Handset Port.

1. Plug in the Primary Handset connector into the Handset port on the BDU front panel. Make sure the key of the handset is aligned to the red mark of the handset port.

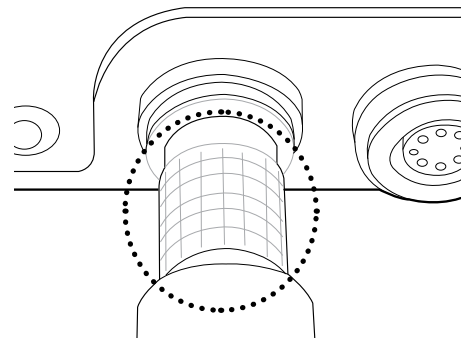

### Connecting the Wi-Fi Antenna

The Primary Handset is powered from the BDU through the Primary Handset Port.

1. Connect the Wi-Fi antenna to the Wi-Fi's connector on the BDU front panel.  
Rotate the connector in the clockwise direction until it is secured.

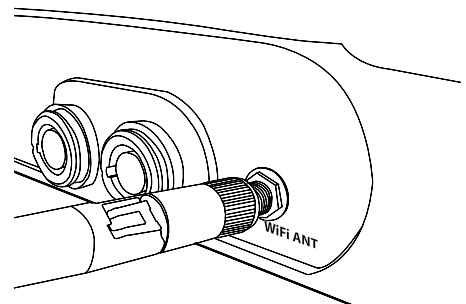

## Powering Up the System

1. Use the ON/OFF switch on the BDU's front panel.

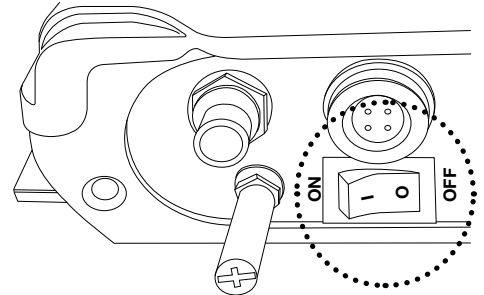

2. Wait for all LED indicators to turn green to indicate the system is completely power up. Refer the table below for meaning of the status indicators.

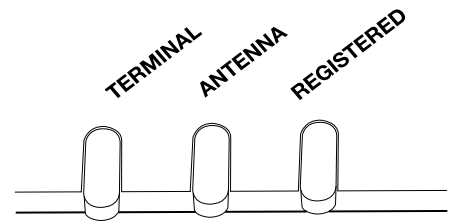

LED Name	Status	Meaning
TERMINAL	Steady Amber	BDU is powering up.
	Steady Green	BDU has powered up successfully.
	Steady Red	BDU detects failure.
	Blinking Amber	Switching OFF BDU.
ANTENNA	Steady Amber	ADU is powering up.
	Steady Red	ADU is not OK/Error
	Blinking Amber	ADU is calibrating
	Blinking Green	System performs satellite search
	Steady Green	ADU has locked on to the satellite.
REGISTERED	Steady Amber	Attempting network registration
	Steady Red	Network failure/Error
	Blinking Amber	Ready for voice only
	Blinking Green	Ready for packet data only.
	Steady Green	Ready for all. (Voice and Data)

### Entering your SIM PIN

When you acquire the SIM card from the Airtime Service Provider, a PIN (Personal Identification Number: 4 to 8 digits) is provided together with it.

**Note:** You will need to enter the PIN at start-up if the FBB BDU has been powered down.

Follow these steps to enter the SIM PIN:

Using the keypad on the Primary Handset, enter the SIM PIN.

Press **Left Selection key**\* to confirm the SIM PIN.

**Note:** You are required to use the PUK code to unlock the SIM card and to reset your PIN code if more than three (3) incorrect attempts were used to enter the PIN code.

---

## 7. USING THE PRIMARY HANDSET

### 7.1 The Primary Handset

The Primary Handset is connected to the FBB UE using the dedicated HANDSET port and is powered directly from the BDU. Equipped with a large 2", 65K CSTN, 220 Liquid Crystal Display (LCD), Primary Handset not only acts as a standard phone that allows you to make/ receive voice calls, it also serves as a remote access UE (User Equipment) for you to access various configurations supported by the BDU.

Primary Handset offers the following features:

- Making standard CS voice calls
- Making standard/streaming PS background data connections
- Messaging (SMS)
- User contacts (combined SIM and BDU storage)
- Speed dial
- Call logs
- Managing BDU security settings
- Accessing BDU settings that includes:
  - o Ethernet
  - o Ciphering control
  - o Satellite selection
  - o Supplementary services
  - o Transceiver restart
  - o Limited factory reset
- Displaying various BDU status and information
- Local handset configurations



## 7.2 Powering Up the Primary Handset

The Primary Handset is automatically powered up once it is connected to the dedicated **HANDSET** port.

Depending on the conditions of the BDU, the Primary Handset may start in the following modes:

### Full functioning mode

In full functioning mode, there is no PIN authentication required to start using the FBB system. All BDU settings including contacts, messages and call logs are loaded into local memory of the Primary Handset once the BDU is configured. You will be able to access all the menus and making voice or data calls once the Primary Handset is ready.

### PIN mode

User is required to enter the correct PIN/password before proceeding to Full functioning mode, Refer to Security settings menu for more information on the types of security PIN in the BDU.

#### To enter the PIN:

1. Key in the PIN of the security key using the alpha-numeric keypad.
2. Press **OK key\*** to confirm.

#### To cancel PIN entering:

1. Press the **Right selection key\***.
2. Confirm to start in Emergency only mode by pressing the **OK key\***.

### Emergency only mode

PIN authentication is bypassed (i.e. when you have forgotten the required PIN). You can only make emergency calls or access local Phone manager menu in this mode.





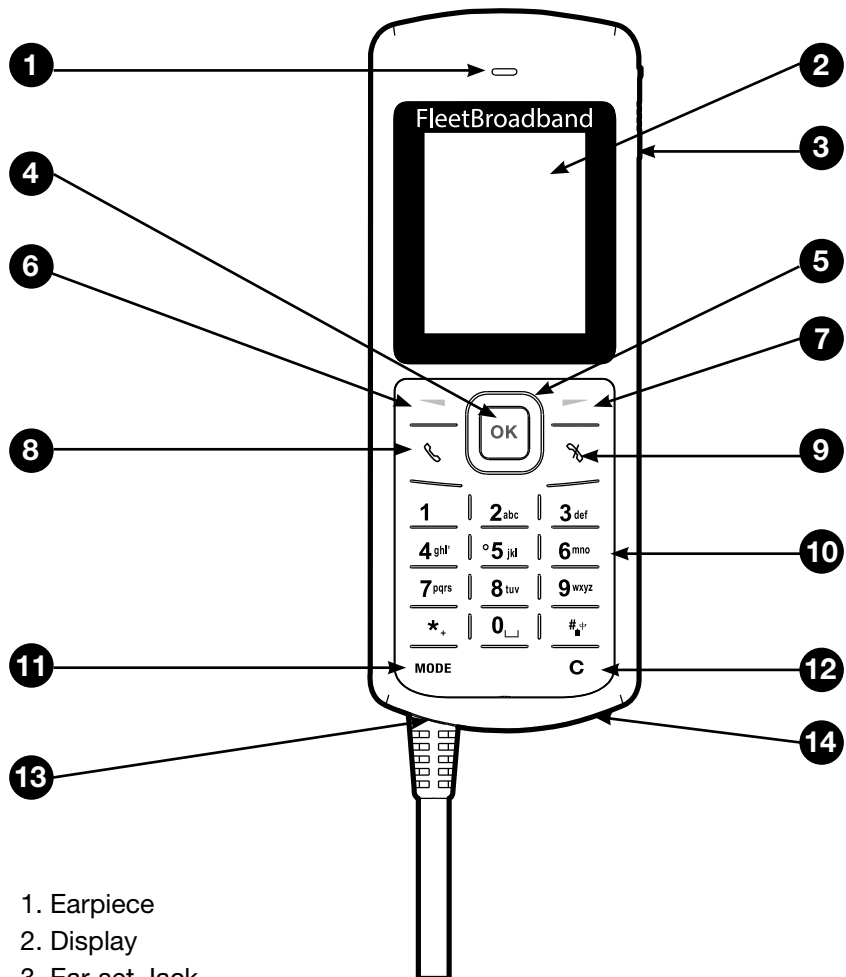





### 7.3 Primary Handset



1. Earpiece
2. Display
3. Ear-set Jack
4. OK Key
5. 4-Way Navigation Ring
6. Left Selection Key
7. Right Selection Key
8. Call/Answer Key
9. Call/Menu End Key
10. Keypad (Alpha-numeric)
11. Mode Key
12. Clear Key
13. Microphone
14. Service Port
15. Ringer\*

\*The ringer is located at the back of the Primary Handset.

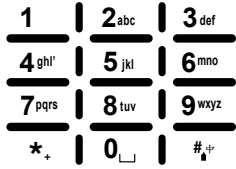
**Keypad - Description and Functions**

Keys	Description / Functions
	<p><b>4-way navigation ring*</b> Press the 4-way navigation ring to scroll left, right, up, and down on the display. Enables scrolling through names, phone numbers, menus or settings.</p>
	<p><b>OK key*</b> Pressing this key selects/confirms the function highlighted on the display.</p>
	<p><b>Left selection key*</b> The function of this key depends on the guiding text shown on the display above the key.</p>
	<p><b>Right selection key*</b> The function of this key depends on the guiding text shown on the display above the key.</p>
	<p><b>Call/Answer key*</b> After entering a phone number: Initiates a call to the number. From Main Display screen: Opens a list of dialed calls When Ringing: Answers the incoming call.</p>
	<p><b>Call/Menu End key*</b> Press this key to end active calls or exits from any menus or sub menus.</p>
	<p><b>Keypad*</b> Used to enter numbers and characters. Press 0 to add a space when writing text. The functions available depend on whether you are typing a phone number (number mode) or text (text mode).</p>
	<p><b>Star key*</b> When entering a phone number, press this key to insert a *. Press and hold this key to insert a +. When writing text, press this key to access a list of special symbols.</p>
	<p><b>Hash key*</b> When entering a phone number, press this key to insert a #. To quickly change the text input method when writing text, press this key repeatedly and check the indicator at the top of the display. In standby mode, press and hold this key to set the Primary Handset into silent mode.</p>
<p><b>MODE</b></p>	<p><b>Mode key*</b> Unplug the handset from BDU, press and hold this key when handset unplugged and plug in the Handset. Handset power up in Firmware Upgrade Mode.</p>
<p><b>C</b></p>	<p><b>Clear Key*</b> Press key once to clear one character at a time or press and hold this key to clear the whole text entry.</p>

---

## The Main Display Screen



### 1. BDU Status Indicator line

The indicator line shows status symbol informing you about the operating conditions of the BDU.

### 2. Satellite

The indicator line shows status symbol informing you about the satellite service.

### 3. Handset Status Indicator line

















The indicator line shows status symbols informing you about the operating conditions of the Primary Handset.

### 4. Selection Key line

The Selection key line operates using the **Left or Right selection keys\*** with the **OK Key\*** to access menus and controls.

### Primary Handset Status Indicators

Table below explains the meaning of each status indicator displayed in the Main Display screen.



Status Indicator	Description
	New short message (SMS) in inbox.
	Available CS domain services.
	Available PS domain services.
	Data connection is inactive. (Available in Manage profiles sub menu only)
	Data connection is active.
	Ciphering is enabled.
	Radio silent is enabled.
	Primary Handset keypad lock is active.
	Primary Handset disconnected from BDU.
	Primary Handset connected to BDU.
	The terminal has locked on to Inmarsat satellite "I-4 Asia Pacific".
	The terminal has locked on to Inmarsat satellite "I-4 EMEA".
	The terminal has locked on to Inmarsat satellite "I-4 Americas".
	Primary Handset in silent mode.
	Telephony CS port is engaged.
	Signal strength.

---

## Primary Handset Operations

### Making a Voice Call

Before making a voice call, please make sure that:

- The Primary Handset is connected to the BDU.  
( Status indicator should be on.)
- The Primary Handset is NOT radio silent. ( Status indicator should be off.)
- The BDU has successfully registered with the network and ready for CS domain (voice) services. ( Status indicator should be on.)

You can use the following two options for making a call:

- Manual Dial:

1. Using the alphanumeric keypad, dial 00 <country code> <phone number>.
2. Press **Call/Answer key\***.



- Using Contacts or Call Log list from the Primary Handset:
  - Enter the Contacts list of the Primary Handset; scroll to the desired number and press **Call/Answer key\***, or
  - Enter the Log list of the Primary Handset; scroll to the desired number and press **Call/Answer key\***.

**Note:** For voice calls and SMS, you may also use '+' by pressing and holding the  key instead of "00" at the beginning of dialled number string as an alternative (,+<country code> <phone number>).

### To End a Call

1. Press **Call/Menu End key\***



### Receiving a call

When there is an incoming call, the Primary Handset will,

- Ring.
- The calling party's number will be displayed on the screen.  
If the number is stored in the contacts, the corresponding name of contact will be displayed.

To answer an incoming call, press the **Call/Answer key\***

### Adjusting volume during a call

Use the 4-way navigation ring **4-way navigation ring\*** to adjust the volume.

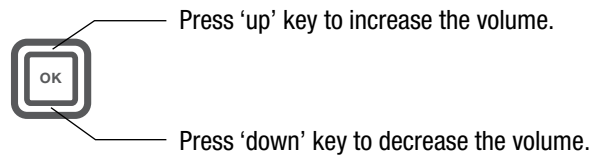

---









## Using the Menus

You can access the Menu System by pressing the **Right selection key\*** in the Main Display screen.

The main menu of the Primary Handset includes nine (9) menu options with each menu option having their respective sub-menus.

You can use the 4-way navigation **4-way navigation ring\*** to navigate to the desired menu option and press **OK Key\*** to confirm your selection. You can also end the menu or sub menu and return to the Main Display screen at any time by pressing the **Call/Menu End Key\***.

Table below summarizes the functionalities within each menu option:

Status Indicator	Description
	<b>Contacts</b> This menu manages your user contacts.
	<b>Log</b> This menu allows you to view call histories.
	<b>Telephony</b> This menu configures settings related to CS voice telephony services.
	<b>Data</b> This menu configures settings or connections related to PS data services.
	<b>Messaging</b> This menu is for SMS related services.
	<b>Settings</b> This menu configures general BDU settings.
	<b>Transceiver</b> This menu displays general BDU information.
	<b>Security settings</b> This menu configures security settings related to the BDU.
	<b>Phone manager</b> This menu configures local handset settings.

### Contacts Menu

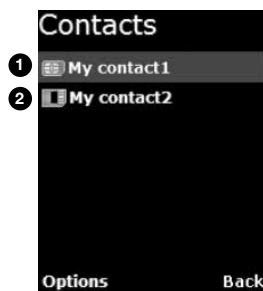

The Contacts menu allows you to store, retrieve and update names and phone numbers of your contacts in the Primary Handset memory and in the SIM card memory. You can also access this menu by pressing **Left selection key\*** in Main Display screen. This menu lists all the contacts saved in both the BDU and SIM card memory where.

- ① Indicates contacts that are saved in BDU and
- ② Indicates contacts that are saved in SIM card.

The following options are available when pressing the **Left selection key\*** while browsing through the contacts:

- **New contact**

Add new contact to the memory. To add contact:

1. Select **New contact**.
2. Select where you want to store the contact (BDU or SIM).
3. Enter the name for the contact.

**Note: Press Star key\* to browse for symbols.**

4. Enter the number for the contact.

**Note: Stored number can be in any one of the following formats:**

- '+' <country code> <phone number>
- 00 <country code> <phone number>

**Press Star key\* to insert '+' sign.**

**Saving of contact without number is not allowed.**

5. Select **Save (Left selection key\*)** or pressing the **OK key\*** to save the contact to the selected memory.



---

**Note:** Refer to “Tips for writing the text” section under New message for more information on text writing.

- **Search** : Select this to enter a specific name to search within the contact list.
- **Delete** : Delete selected contact.

**Note:** You can also delete the selected contact by pressing the **Clear key\***.

- **Copy** : Select this to copy the selected contact from SIM card memory to BDU memory or vice versa.
- **View number** : Display the number of the selected contact.
- **Assign Speed Dial** : Add the selected contact to the speed dial list.
- **Reload Contacts** : Select this to reload contacts from the BDU/SIM card into the local memory of the Primary Handset.
- **Memory Status** : Select this to view the memory status of the contacts.

While browsing through the contact list, press the **OK key\*** to view the phone name and number or the selected contact. The following options are available when pressing the **Left selection key\*** while viewing the selected contact:

- **Call** : Make a voice call to this contact.
- **Send message** : Open a SMS editor to send a text message to this contact.
- **Edit contact** : Edit information of this contact.
- **Delete** : Delete this contact.
- **Copy** : Select this to copy this contact from SIM card memory to BDU memory or vice versa.
- **Forward contact** : Forward information of this contact using SMS.
- **Assign Speed Dial** : Add this contact to the speed dial list.

**Note:** You can also make a voice call to the selected contact when browsing through or viewing the contacts by pressing the **Call/Answer key\***.

## Log Menu



The Log menu allows you to view historical information about phone calls and data usage in chronological order with the following sub menus:

- ① Missed calls
- ② Received calls
- ③ Dialled calls

Call history of the particular category is displayed in chronological order when selected. Up to 5 latest entries of each category can be saved.

The following options are available when pressing the **Left selection key\*** while browsing through or viewing the call log:

- **Delete**  
Delete the selected log entry from the list.  
**Note:** You can also delete the entry by pressing the **Clear key\***.
- **Call**  
Call the number in the selected log entry.
- **Send**  
Send an SMS to the number in the selected log entry.
- **Save**  
Save the number from the selected log entry to the contact list.

**Note:** This option is not available when the log entry already has an entry in the contact list.

**Note:** You can also make a voice call to the number of the selected log entry when browsing through or viewing the call log by pressing the **Call/Answer key\***.

### Clear call lists

Select this to clear the call log entries. Available log options are:

Missed calls

- **Received calls**
- **Dialled calls**
- **All calls**

Delete all logs including **Missed**, **Received** and **Dialled** logs.

### Call/Data usage

Display the accumulated call and data duration. Press **Left selection key\*** to clear the call or data duration.

---

## Telephony Menu

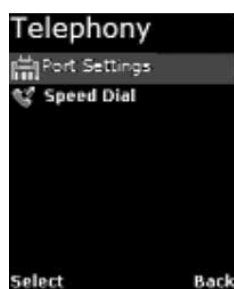

The Telephony menu allows you to configure telephony related settings with the following sub menus:

### Port Settings

- Primary Handset  
Contain options for incoming and outgoing call types.  
Select this to configure the call type settings. The following options are available when pressing the **Left selection key\*** while browsing through the list:
  - Standard
  - NONE
- Phone Port  
Contain options for incoming and outgoing call types.  
Select this to configure the call type settings. The following options are available when pressing the **Left selection key\*** while browsing through the list:
  - Standard
  - High quality [ fact: only applicable if fax is purchased ]
  - BOTH (only for incoming) [fact: only applicable if purchase fax]
  - NONE
- Fax (OPT) Port  
Contain options for incoming and outgoing call types.  
Select this to configure the Fax type settings.  
The following options are available when pressing the **Left selection key\*** while browsing through the list:
  - High quality [fact: only applicable if purchase fax]
  - NONE

## Speed dial

- **Setting**  
Contain options to enable/disable the speed dial feature
- **Speed Dial List**  
Select this to configure the speed dial list. The following options are available when pressing the **Left selection key\*** while browsing through the list:
- **Assign**  
Assign a contact to the selected entry. To assign a contact:
  1. Select Speed Dial List.
  2. Browse through the list to locate an empty entry.
  3. Select Options by pressing **Left selection key\***.
  4. Select Assign and press **OK key\*** from the option.
  5. Select the desired contact to assign to the speed dial list.
  6. Press **OK key\*** to confirm your selection.
- **Delete**  
Remove contact from the selected entry. This option is not available for empty entry.  
  
**Note:** You can also delete the entry by pressing the **Clear key\***.
- **Call**  
Make call using the number from the selected entry.  
This option is not available for empty entry.

**Note:** You can also make a voice call to the number of the selected entry by pressing the **Call/Answer key\***.

You can make a voice call directly from the Main Display screen by pressing the corresponding speed dial entry number + **Call/Answer key\*** once the speed dial feature is enabled with a valid contact entry.

---

## Data Menu

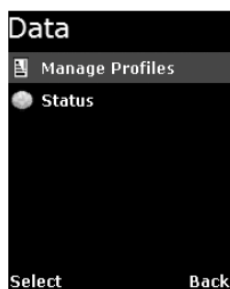

The Data menu provides the following sub menus to manage and configure data connections (PDP profiles) for the BDU:

### Manage profiles

Allow you to manage the Primary and Secondary PDP profiles.

- Primary profiles  
One Standard Primary PDP profile has been created in the Primary profile list as a default profile. The profiles listed in the list are:
  - Standard
  - 32k Streaming
  - 64k Streaming
  - 128k Streaming

You can press the **Left selection key\*** for options available when browsing through the profile list. The list of options is:

- o **Edit**  
Edit the selected profile.
- o **Delete**  
Delete the selected profile.
- o **Add**  
Add new profile into the list.
- o **Reset table**  
Reset profile list. All profiles will be deleted and a default profile is created.

### Adding / Editing profiles

You can press the **Left selection key\*** or **OK key\*** from the option list to add new or edit existing profile settings.

- **Profile name**

Specify the name of the profile.

- **Connection type**

Both **Standard and Streaming** connection types are supported.

- **APN**

Specify information of the APN (Access Point Name). Further available settings are:

**APN:** Specify the Access Point Name for the connection. Default APN is according to SIM card. Enter your own APN if you do not want to use the default APN from the SIM card.

**Username:** Specify the user name for **Static** IP configuration. Default is blank for **Dynamic** IP configuration.

**Password:** Specify the password for **Static** IP configuration. Default is blank for **Dynamic** IP configuration.

You can press the **Left selection key\*** for the following options:

- **Edit**

Edit the selected APN setting

- **Fetch from SIM**

Fetch the APN from the SIM card. This option is only available when APN is highlighted.

- **IP configuration**

Contain options for **Static** or **Dynamic** IP. Default is **Dynamic** IP configuration.

- **IP address**

Specify the IP address for **Static** IP configuration.

This field is ignored for **Dynamic** IP configuration. Default is blank for **Dynamic** IP configuration.

- **Header comp.**

Contain options to enable or disable header compression. Default is **Enabled**.

---

**Note:** For 32k, 64k and 128k Streaming profiles, there are three additional options when selecting editing their settings. The additional options are:



- **Desired rate**  
Choose the desired rate for the different profiles. Note that the default setting for each profile is the profile chosen. For example, for 32k Streaming, the default rate is 32k.
- **Minimum rate**  
Choose the minimum rate for the different profiles. Note that the default setting for each profile is the profile chosen. For example, for 32k Streaming, the default rate is 32k.
- **Error correction**  
Contain options to enable or disable error correction.  
Default is disabled.
- **Secondary Profiles**  
The profiles listed in the list are:
  - FTP
  - Quick Link
  - Quick Time Media
  - Real Media
  - Stream Box
  - Win Media

### **Adding/Editing profiles**

You can press the **Left selection key\*** or **OK key\*** from the option list to add new or edit existing profile settings.

- **Profile name**  
Specify the name of the profile.
- **TFT**  
Choose desire type of connection.
- **Desired rate**  
Choose the desired rate for the profile. Default settings for all secondary profiles are set as 32K.
- **Minimum rate**  
Choose the minimum rate for the profile. Default settings for all secondary profiles are set as 32K.
- **Error correction**  
Contain options to enable or disable error correction.  
Default is Disabled.

**Note:** You will be prompted to save the changed settings before exiting the sub menu. Press **Left selection key\*** or **OK key\*** to save the changes.

Icon  in the profile list indicates that the profile is not active and icon  indicates that the profile is currently active in use.

### Status

Allow you to check the status of the data connection. You can also activate / de-active a specific profile in the status display list.

**Note:** You will not be able to enter this sub menu if the BDU has not been registered for PS data service.

The status list shows you the current active data connection. Depending on whether there is an active connection, you can press the **Left selection key\*** for the following options:

- **Activate Primary**  
This option is available when there is no active data connection. Select this to choose from the profile list for activation.
- **Deactivate**  
This option allows you to deactivate an active data connection.

### To active a primary data connection when there is no active connection:

1. From the data status list, select Options using the **Left selection key\***.
2. Select Activate primary using **Left selection key\*** or **OK key\***.
3. Select from a list of configured primary profile for activation.  
Press **Left selection key** or **OK key\*** to confirm.
4. You are prompted to confirm activation. Confirm activation by selecting yes using the **Left selection key** or **OK key\***.

**Note:** It may take a while to active a data connection.



---

### To de-activate a primary data connection when there is an active connection:

1. From the data status list, select Options using the **Left selection key\***.
2. Select Deactivate using **Left selection key\*** or **OK key\***.
3. You are prompted to confirm de-activation. Confirm de-activation by selecting Yes using the **Left selection key\*** or **OK key\***.

### Messaging Menu



The **Messaging** menu allows the user to write a new message, view stored messages from **Inbox**, **Drafts** and/or **Sent** folders and configure settings related to SMS with the following sub menus:

#### 1 New Message

Select this to create and send a new message. To create new message:

1. Select **New Message** by pressing the **OK key\***.  
A SMS editor will be displayed on the Primary Handset screen for writing new message.
2. Type in your SMS message using the alphanumeric keypad.
3. To send the message, press the **OK key\*** and select Send.
4. Enter the recipient's phone number, and press the **OK key\***.  
Alternatively you can select **Search** by pressing the **Left selection key\*** to select the phone number from the contacts.

Options:

You can press the **Left selection key\*** to select options available when writing the message.

- **Send**  
Select this when you are ready to send your message.
- **Save**  
Select this to save the message into the **draft** folder.
- **Clear screen**  
Select this to clear all the written text.

**Tips for writing the text:**

- Press the **0** key to add a space.
- To quickly change the text input mode when writing text, press **Hash key\*** repeatedly and check the indicator at the top of the display:
  - o <ABC>: Capital letters
  - o <123>: Numbers
  - o <abc>: Small letters
  - o <Abc>: Initial Capital letter followed by small letters
- To add a number in alphabet mode, press and hold the desired number key.

**Inserting symbols to your message:**

- To get a list of special symbols, press the **Star key\***.
- Using the **4-way navigation ring\***, navigate to the desired symbol.
- Press **Ok key\*** to confirm selection.

**Clearing text:**

- To clear text, press **Clear key\*** once to clear one character at a time.
- To clear the whole text entry, press and hold **Clear key\*** to clear the whole text entry.

**② Inbox**

Contain new/opened text messages that you have received. When browsing through the messages list using the **4-way navigation ring\***,



Indicates an unread (new) message and



Indicates read (opened) text messages.

The following are available options when pressing the **Left selection key\*** while browsing through or viewing the messages in this folder:

---

The following are available options when pressing the **Left selection key\*** while browsing through or viewing the messages in this folder:

- **Open**  
Open selected message. You can also press **OK key\*** while browsing through or viewing the messages in this folder:
- **Reply**  
Select this to reply to the selected message sender.
- **Delete**  
Delete selected message.

**Note:** You can also delete the selected message by pressing the **Clear key\***.

- **Forward**  
Forward this message to another recipient.
- **Call**  
Make a voice call to the selected message sender.
- **Save**  
Save the selected message into the Draft folder.
- **Details**  
Display the details of the selected message.
- **Add to contact**  
Select this to add the phone number of the selected message into the contact list.

**Note:** You can also make a voice call to the selected message contact when browsing through the messages list by pressing the **Call/Answer key\***.

### Sent

Contain text messages that you have sent. The following are available options when pressing the **Left selection key\*** while browsing through or viewing the messages in this folder:

- **Open**  
Open selected message. You can also press **OK key\*** while browsing through the message list to open the selected message (This option is not available when viewing the message).
- **Delete**  
Delete selected message.

**Note:** You can also delete the selected message by pressing the **Clear key\***.

- **Send**  
Send the selected message to another recipient.
- **Save**  
Save the selected message into the Draft folder.
- **Add to contact**  
Select this to add the phone number of the selected message into the contact list.

**Note:** You can also make a voice call to the selected message contact when browsing through the message list by pressing the **Call/Answer key\***.

### Draft

Contain text messages that you have saved. The following are available options when pressing the **Left selection key\*** while browsing through or viewing the messages in this folder:

- **Open**  
Open selected message. You can also press **OK key\*** while browsing through the message list to open the selected message (This option is not available when viewing the message).
- **Delete**  
Delete selected message.

**Note:** You can also delete the selected message by pressing the **Clear key\***.

- 
- **Send**  
Send this message to another recipient.
  - **Save**  
Save the selected message into the Draft folder.
  - **Add to contact**  
Select this to add the phone number of the selected message into the contact list.

**Note:** You can also make a voice call to the selected message contact when browsing through the message list by pressing the **Call/Answer key\***.

#### **OPTIONS**

The following settings are available in this sub menu:

- **Message Centre**  
Select this to set the number of the SMS service centre.
- **Save sent message**  
Select this to enable or disable the saving of sent messages.  
When this option is enabled, all successfully sent messages are saved in the Sent folder.
- **Memory status**  
Select this to view the memory status of the messages.
- **Reload Messages**  
Select this to reload messages from the BDU into the local memory of the Primary Handset.

#### **DELETE ALL**

Select this to clear the messages in a particular folder. Available folder options are:

- **All messages**  
Delete messages in all folders including Inbox, Sent and Draft.
- **Inbox**
- **Sent**
- **Draft**

## Settings Menu

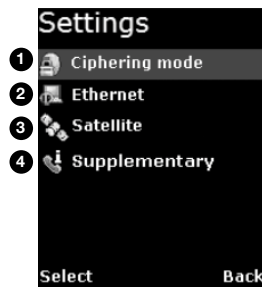

The Settings menu provides the following sub menus to configure the BDU:

### Ciphering mode

Contain options to enable/disable the use of ciphering mode between the network and BDU.

**Note:** Status icon  is displayed in the Main Display screen when ciphering is enabled.

### Ethernet

Allow you to configure settings related to Ethernet connection.

- **Transceiver IP Address**  
Specify the IP address of the BDU.  
The default IP address of the BDU is 192.168.1.35
- **Subnet Mask**  
Specify the subnet mask of the BDU.  
The default subnet mask of the BDU is 255.255.255.0
- **DHCP settings**  
Display the status and settings of the DHCP server.
  - **DHCP server:** Display the status of the DHCP server.
  - **Start IP address:** Display the start IP address of the DHCP server.  
Default start IP address is 192.168.1.40.
  - **End IP address:** Display the end IP address of the DHCP server.  
Default end IP address is 192.168.1.59.
  - **Primary DNS:** Display primary DNS server address.  
Default primary server is 172.30.66.7.
  - **Secondary DNS:** Display secondary DNS server address.  
Default secondary server is 172.30.34.7.

---

#### - Lease time

Display the lease time. Default lease time is 60.

Except for DHCP server, the rest of the display settings can be edited by pressing the **Left selection key\*** or **Ok key\*s**.

**Note:** Make sure that the format is correct when entering an IP address. Press the **Star key\*** multiple times to insert the “.” sign.

### Satellite

Manage settings related to Inmarsat satellites.

- **Satellite selection**  
Allow you to select the preferred satellite to lock on to.  
Default is AUTO where the BDU automatically searches for the best satellite in view to lock on to.

#### **Note:**

Satellites visible to the BDU are marked with \*. The BDU will de-register from the network with all the CS (voice) and PS (data) services terminated whenever a new satellite is manually selected from the list. The BDU can only re-register with the network once it has successfully locked onto the newly selected satellite.

### Satellite status

Display current satellite status. The following information is displayed:

#### - Status

Display status of the BDU. The BDU can be either searching or locked on to a particular satellite.

#### - Satellite ID

Satellite ID that the BDU is currently searching for or locked on.

#### - Satellite Name

Satellite Name that the BDU is currently searching for or locked on.

**Supplementary**

Configure settings related to supplementary services. These settings are applicable to standard CS voice services.

**Note:** Depending on the network, some settings may not be available or may prevent other settings from being activated.

The following information is available:

- **Call forwarding**  
Allow you to configure for call forwarding services depending on various conditions. The following forwarding conditions are available for configurations:
  - **All Calls**  
All calls are unconditionally forwarded.
  - **Busy**  
Calls are forwarded when the BDU is busy.
  - **No answer**  
Calls are forwarded when no answer from the BDU for a specific time.
  - **Not reachable**  
Calls are forwarded when BDU is not reachable.

You can press the **Left selection key**\* for options available when browsing through the list of forwarding conditions. The list of options is:

- **Retrieve all**  
Retrieve network settings of all the listed conditions.
- **Update all**  
Update configured settings of all the listed conditions to the network.
- **Cancel all**  
Deactivate all condition settings.

**Note:** Operations on this level affect all forwarding conditions and hence it may take some time to process.



---

Pressing the **OK key\*** configures a particular forwarding condition. The following settings can be configured:

**Status:** Display active or inactive status of the selected forwarding condition. Press the **OK key\*** to change the status.

**Number:** Display number to forward calls to when selected forwarding condition is active. Press the **OK key\*** to change the number.

**Time:** Only applicable to No answer forwarding condition. To forward calls to selected number if call no answer for a specific period of time. Press the **OK key\*** to change the time.

You can press the **Left selection key\*** for options available when configuring a particular forwarding condition. The list of options is:

- **Retrieve**  
Retrieve network settings of the selected condition.
- **Update**  
Update configured settings to the network for the selected condition.

**Note:** Always use Retrieve all or Retrieve options to retrieve the latest settings from the network. Use Update all or Update options to update the network settings after configurations.

- **Call barring**  
Allow you to configure for call barring services depending on various barring conditions. The following conditions are available for activations/deactivations by pressing the key:
  - **Outgoing calls**  
Barring of all outgoing calls.
  - **Incoming calls**  
Barring of all incoming calls.
  - **Int. except home**  
Barring of all outgoing international calls except to home country.
  - **Incoming if abroad**  
Barring of all incoming when roaming.

You can press the **Left selection key**\* for options available when browsing through the list of barring conditions. The list of options is:

- **Retrieve**  
Retrieve network settings of the highlighted condition.
- **Retrieve all**  
Retrieve network settings of all the listed conditions.
- **Update**  
Update configured settings to the network for the highlighted condition.
- **Update all**  
Update configured settings of all the listed conditions to the network.
- **Cancel all**  
Deactivate all condition settings.

You will be asked to enter the call barring password when updating the settings to the network. Consult your equipment distributor if necessary.

**Note:** Always use Retrieve all or Retrieve options to retrieve the latest settings from the network. Use Update all or Update options to update the network settings after configurations.

- 
- **Call Waiting**  
Contain options to enable/disable call waiting services.  
You can also press the Left selection key for the following options:
  - **Retrieve**  
Retrieve network settings of the call waiting service.
  - **Update**  
Update configured settings to the network.

**Note:** Always use Retrieve option to retrieve the latest settings from the network. Use Update option to update the network settings after configurations.

- **Caller ID**  
Allow you to configure settings that are related to caller identifications.
  - **Setting**  
Contain options to configure for USA or Europe caller ID type.
- **Send Caller ID**  
Allow you to enable/disable sending of your caller ID to the recipient when making a call. Default is AUTO where the default network settings are used. You can also press the **Left selection key\*** for the following options:
  - **Retrieve**  
Retrieve network settings of the waiting service.
  - **Update**  
Update configured settings to the network.

**Note:** Always use Retrieve option to retrieve the latest settings from the network. Use Update option to update the network settings after configurations.



### Terminal Menu



The **Transceiver** menu provides the following sub menus to check for information and perform resets on the BDU:

### Signal strength

Show graphical representation of current signal strength and GPS type. Table below describes the available GPS type icons used in this sub menu:

	This icon shows that the BDU is in the process of acquiring a GPS fix when there is no previously stored GPS fix.
	This icon shows that the BDU is using New GPS coordinates.
	This icon shows that the BDU is using previously stored GPS coordinates.

### GPS status

Show current Latitude and Longitude coordinates, the GPS type and Time of acquisition on the BDU.

### Transceiver Info

Display a list of information of the BDU.

- Manufacturer: Manufacturer name of the BDU
- Software version: Software version of the BDU
- Model: Model name of the BDU
- IMEI number: IMEI number of the BDU
- IMSI number: IMSI number of the SIM card
- Subscriber number: Subscriber's telephone number
- Serial number: Serial number of the BDU

---

### **Antenna Unit Info**

Display a list of information of the Antenna.

- **Serial number**

Serial number of the Antenna

### **Transceiver restart**

Soft restarting the BDU

### **Limited reset**

Perform limited reset on the BDU. Apart from full factory reset that is not available in Primary Handset, limited reset only resets a small portion of the BDU settings. Stored GPS status, contacts, call logs and event logs are not cleared during limited reset.

You are also required to key in the password when performing the reset. The default password is 0000.

**Note:** This password is the same as Terminal PIN.

### Security settings Menu

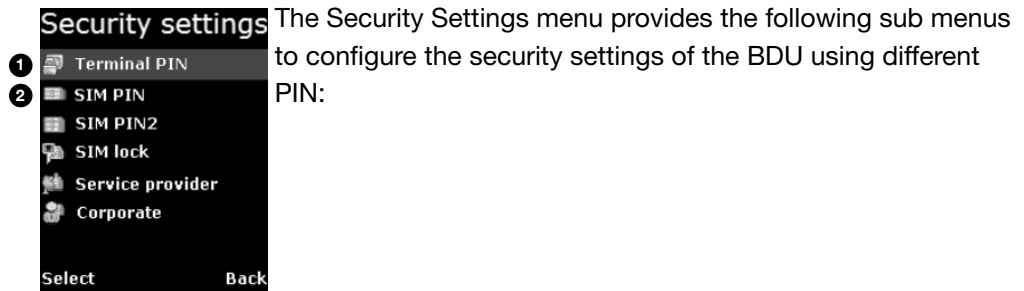

- ① Terminal PIN
- ② SIM PIN

There are three options available for selection under each sub menus to manage the PIN and security settings for the BDU:

- **Enable**  
Enable the selected PIN. Table below summarizes the default PIN codes for each security setting:

Terminal PIN	0000  Note: Terminal PIN is the same PIN that has to be entered when performing Limited Reset on the BDU.
SIM PIN	Depends on your SIM card. Consult your equipment distributor if necessary.  <b>Note:</b> You have to enter the PUK (PIN Unblocking Key) to access the SIM card if a wrong PIN for SIM PIN has been entered for three times. You will be asked to enter the new PIN code once you have entered the correct PUK. However, the SIM card is no longer usable if you have entered wrong PUK for 10 times.

You will be asked to key in the existing PIN (or default PIN if it has not been changed) before the PIN can be enabled.

- **Disable**  
Disable the selected PIN. You will be asked to key in the existing PIN (or default PIN if it has not been changed) before the PIN can be disabled.
- **Change**  
Change the PIN to a new one. You will be asked to key in the existing PIN (or default PIN if it has not been changed) before the PIN can be changed.

**Note:** PIN has to be enabled before it can be changed.

---

## Phone manager Menu



The Phone manager menu provides the following sub menus to configure settings that are local to the Primary Handset:

### Display

Configure settings that are related to Primary Handset display.

- **Backlight**

To set the duration of the display backlight to remain on.

Settings range from Always On (Backlight permanently turned on), 15 seconds to 1 minute.

**Note:** The backlight will be slightly dimmer and finally off when there is no keypad activity after sometime. However, this feature is not available when the setting is set to Always On.

### Tone

Configure tone setting for the standard and ring tones.

- **Standard tone**

- **Key tone**

Contain options to enable/disable the key tone.

- **Message tone**

Contain options to enable/disable the message tone.

- **Volume**

Configure the volume for the standard tones (both key and message tones).

Using the **4-way navigation ring\***, press up/right to increase and down/left to decrease the volume.

- **Ring tone**

- **Tone**

- Select desired ring tone pattern.

- **Volume**

- Configure the volume of the ring tone. Using the **4-way navigation ring\***, press up/right to increase and down/left to decrease the volume.

### **Language**

Allow you to change the menu display language.

### **Factory settings**

Allow you to configure default factory settings of the Primary Handset.

Contains the following settings:

- **Factory reset**

- Perform factory reset on the Primary Handset

### **About**

Display a list of information of the Primary Handset.

- **Model**

- Model name of the Primary Handset

- **Software version**

- Software version of the Primary Handset

- **Hardware version**

- Hardware version of the Primary Handset

- **Technical support**

- Web address for technical support

- **Copyright**

- Contain Copyright message



---

## 8. USING THE WEB CONSOLE

### 8.1 Register to the Network

1. Connect your computer to the FBB BDU using a LAN cable.
2. When the connection has been established, open the web browser.
3. Type `http://192.168.1.35` in the Address field and press Enter.

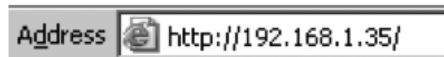

4. When the Login screen appear, type in `admin` in the Username field and `1234` in the password field. Click Login.

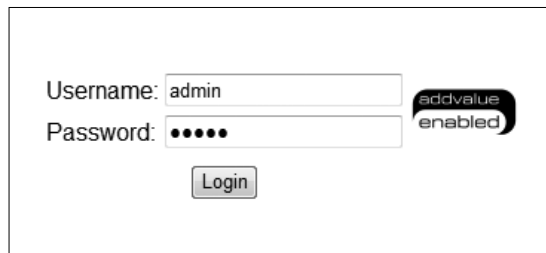
A screenshot of a login screen. It features two input fields: 'Username:' with the text 'admin' and 'Password:' with five dots. To the right of the password field is a logo that says 'addvalue enabled'. Below the password field is a 'Login' button.

5. Click the Login button.

The FBB BDU **Web Console** will appear on your screen.

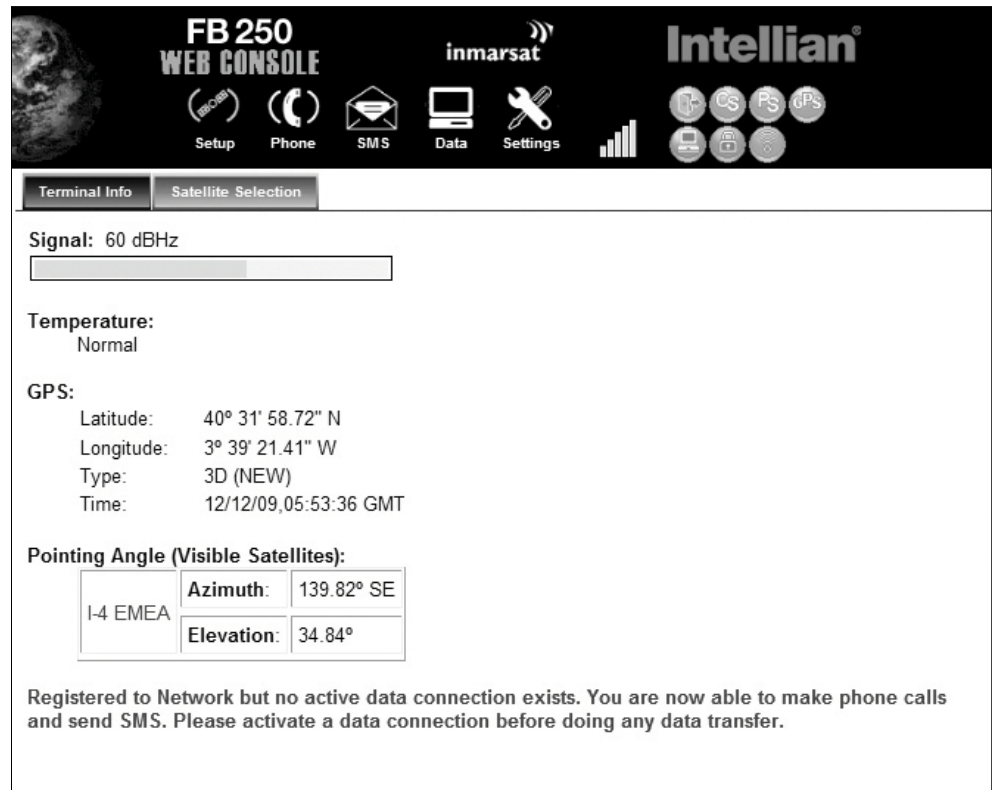

The FBB BDU will automatically register to the network. This process will include GPS acquisition, satellite tracking and registration with the network, which will take a few minutes.

Once the process is completed, you will see the following message appearing at the bottom line of the Web Console.

**“Registered to Network but no active data connection exists. You are now able to make phone calls and send SMS. Please activate a data connection before doing any data transfer”**

Upon successful registration, with all three BDU’s LED indicators lit in green, the UE will be ready for normal operation.

## 8.2 Navigating the Web Console

### Menu Overview



Below you can see all of the sub menu tabs, under each icon menu item.

Setup	Phone	SMS	Data	Settings
Terminal Info	Phonebook	Compose	Connection	Language
Satellite Selection	Call History	Inbox	Primary Profiles	Terminal Info
		Sent	Port Forwarding	Ethernet
		Draft	Firewall	Telephony
			PPPoE	PIN
			Settings	SMS
				Tracking
				Admin
				Support
				Accounts



### Status/Action Indicators



These icons indicate the status of the FBB BDU.

- Orange indicates the item is active.
- Grey indicates the item is inactive.





**Status Icons**

Status Indicator	Description	
	Circuit Switch Icon	Indicates the Circuit Switch service status (Voice calls, SMS, FAX).
	Packet Switch Icon	Indicates the Packet Switch service status (Internet Browsing, FTP, email.)
	GPS Icon	Indicates if a new GPS fix is available or not.

These icons indicate the status of the FBB BDU and also function as shortcut buttons to the respective menu as indicated below.

- Orange indicates the item is active.
- Grey indicates the item is inactive.

**Action Status Icons**

Status Indicator	Description	
	Logout Icon	Click on this icon to log out from the web console.
	Internet Icon	Indicate whether the unit is connected to the internet. Click on this icon to go to Data menu.
	CIPHERING Icon	Indicate that ciphering is enabled or disabled. Click on this icon to CIPHERING Menu.
	Radio Silence Icon	indicates if radio silence is enabled or disabled. Click on this icon to CIPHERING Menu.

## 8.3 Navigating the Web Console Setup Menu

Viewing Terminal Information



1. Click on Setup icon.
2. Click **Terminal Info**.

The terminal information tab shows Signal strength, Temperature, GPS Status, Elevation angle and Registration status.

<b>Signal</b>	Indicates the received signal strength (C/No in dB Hz).
<b>Temperature</b>	Indicates the UE's current operating temperature status.
<b>GPS</b>	Indicates the latitude, longitude, type and time of the GPS acquisition.
<b>Pointing Angle</b>	Indicates the azimuth and elevation angle of the antenna with the corresponding satellite in view.

### Satellite Selection

The default Satellite Selection is in **Auto** mode. In **Auto** mode, the UE will scan all the visible satellites and track the satellite with the most optimum elevation angle or the last used satellite.

**Note:** Changing the satellite selection will terminate any existing active voice/fax call or data connections.

Follow these steps to change your satellite selection

1. Click on Setup icon
2. Click the **Satellite Selection** to view the visible satellites.  
The visible satellites will be displayed for your selection.  
It also displays the satellite information that your Antenna Unit's is locked on to.

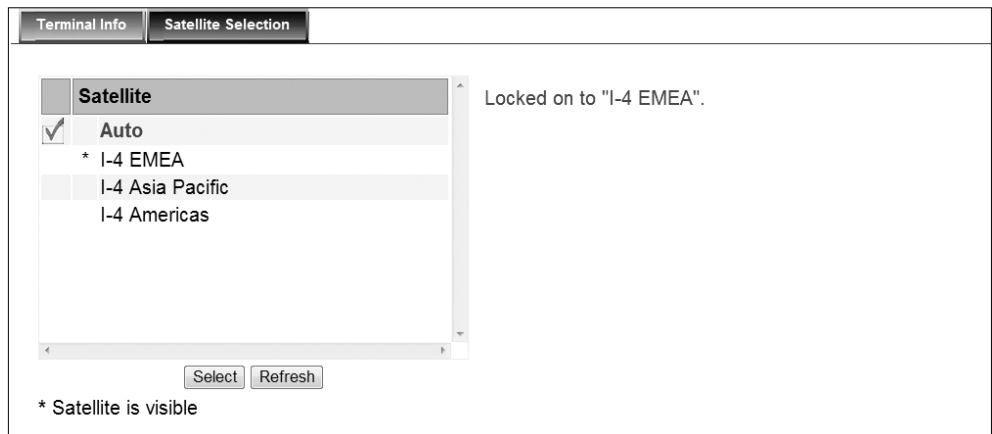

3. Click on your choice of visible satellites.
4. Click the Select button to point the antenna to the selected satellite in exclusive mode. The satellite selection will be saved, and each time you power up the UE, the satellite selection choice will remain until you make the next selection change. The UE will track the newly selected satellite even if the elevation angle is not optimum.
5. Click Refresh to refresh the Satellite list.

---

## Phone Menu



1. Click on Phone icon

Phone menu provide the following options:

### I. PhoneBook

- The Phonebook entries can be stored on the SIM card or the FBB BDU.
- Allows you to view, add, edit and delete entries on your Phonebook list.
- You can make and send SMS messages directly from your Phonebook entries.



### View option

The View option allows you to view the Phonebook entries from the different storage locations.

From the drop-down menu, select:

<b>All</b>	To view the entries stored in the SIM card and FBB BDU.
<b>SIM only</b>	To view the entries stored in the SIM card.
<b>Transceiver only</b>	To view the entries stored in the FBB BDU.

### Storage Usage

Shows the number for Phonebook entries used in the SIM card and TU locations.

For example: **(SIM -2/150)** indicates: Storage location – **SIM** card

Total number of entries used = **2**

Total number of entries available = **150**

**Adding Phonebook Record**

Name:

Phone no.:

Save Phonebook record in  SIM  Terminal

### Adding a new Phonebook entry

- Click Add.
- Enter the Name and Phone number.
- Select the storage location and click Save.

**Phonebook Edit**

Name:

Phone no.:

### Editing a Phonebook entry

- Select the entry from the Phonebook list.
- Click Edit.
- Proceed to change the Name and/or Phone number.
- Click Apply.



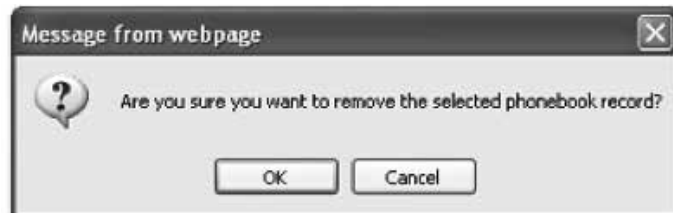

### **Deleting a Phonebook entry**

- Select the entry from the Phonebook list
- Click Delete.
- Click Ok to confirm to delete the entry

### Sending SMS from the Phonebook

Follow these steps to send SMS from the Phonebook:

1. Select the entry from the Phonebook list.
2. Click Send SMS.
3. The Phonebook console switches over to the Compose SMS console.

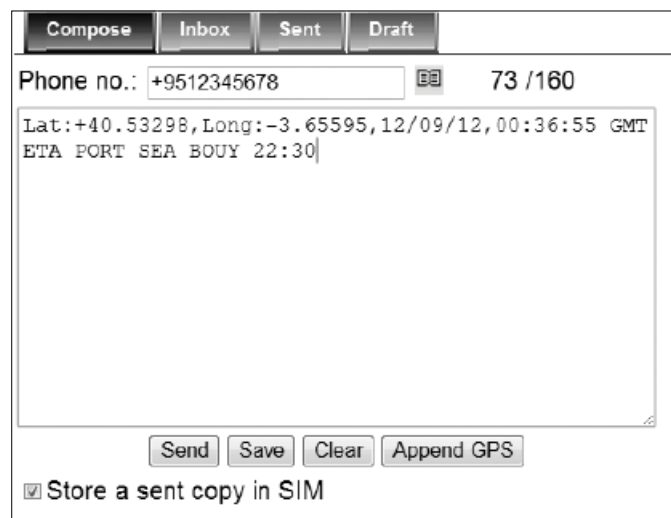

4. Type in the text message and click Send.

### II. Call History

To check history log of calls made and received.

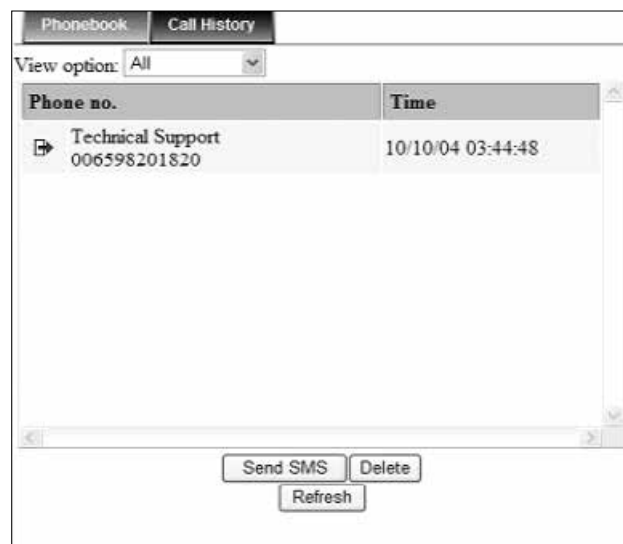

---

### View option

The View option allows you to view the Call History entries.  
From the drop-down menu, select:

<b>All</b>	To view the list of the dialed, received and missed calls.
<b>Dialed Call</b>	To view the list of dialed calls only.
<b>Received Call</b>	To view the list of received calls only.
<b>Missed Call</b>	To view the list of missed calls only.

### Sending SMS from the Call History list

Follow these steps to send SMS from the Call History list:

1. Select the entry from the list.
2. Click Send SMS.
3. The Call History console switches over to the Compose SMS console.

The screenshot shows the 'Compose' screen of a mobile application. At the top, there are four tabs: 'Compose', 'Inbox', 'Sent', and 'Draft', with 'Compose' being the active tab. Below the tabs, there is a 'Phone no.' field containing '+9512345678' and a character count '73 /160'. A large text area contains the message content: 'Lat:+40.53298,Long:-3.65595,12/09/12,00:36:55 GMT' followed by 'ETA PORT SEA BOUY 22:30'. At the bottom of the text area, there are four buttons: 'Send', 'Save', 'Clear', and 'Append GPS'. Below these buttons, there is a checkbox labeled 'Store a sent copy in SIM' which is currently checked.

4. Type in the text message and click Send.

### Deleting a Call History entry

Follow these steps to delete a call History entry:

1. Select the entry from the Call History list.

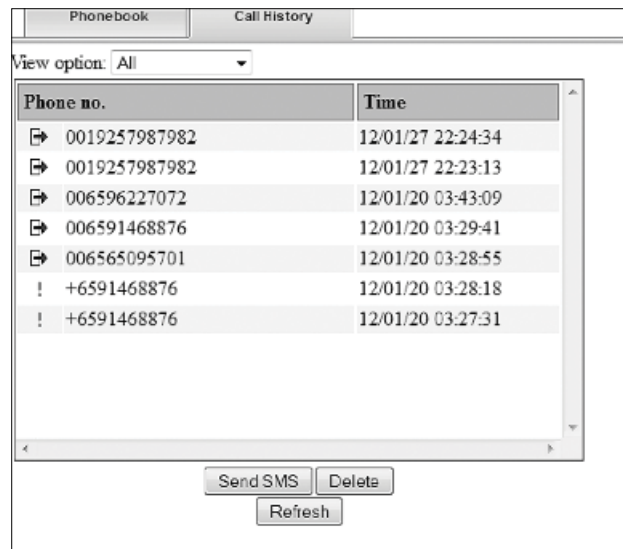

2. Click **Delete**.
3. Click **Ok** to confirm or click **Cancel** to abort deleting the entry.
4. Click Refresh to refresh the Call History list.

---

## SMS Menu



1. Click on SMS icon.

SMS menu provide the following options:

### I. Compose

To compose and send text messages.

Simply enter a mobile number, type your message and click Send.

### II. Inbox

Shows the details (Sender information, Message, Date and Time stamp) of all SMS received.

### III. Sent

Shows the details (Receiver information, Message, Date and Time stamp) of all SMS sent.

### IV. Draft

Stores unsent messages for retrieval later.

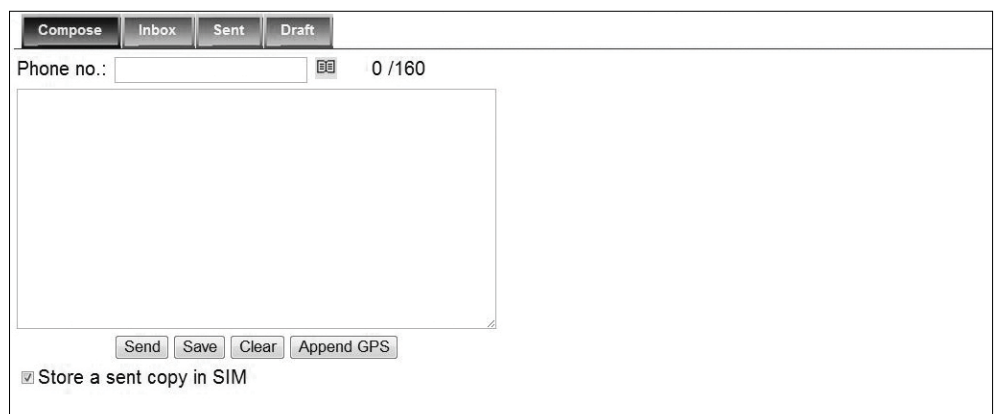

Compose    Inbox    Sent    Draft

Phone no.:  0 / 160

Store a sent copy in SIM

Send    Save    Clear    Append GPS

## I. Compose

### Composing a New Message

Follow these steps to compose a new SMS:

1. Enter the receiver's Phone number in the Phone no. field or click the Phone-book icon if the receiver's number is listed in the Phonebook.
2. Type the message in the text editor box.

The screenshot shows the 'Compose' screen of a mobile device. At the top, there are four tabs: 'Compose', 'Inbox', 'Sent', and 'Draft'. Below the tabs, there is a 'Phone no.' field with the number '+9512345678' and a character count '73 /160'. Below the phone number field is a text editor box containing the message: 'Lat:+40.53298,Long:-3.65595,12/09/12,00:36:55 GMT ETA PORT SEA BOUY 22:30'. At the bottom of the screen, there are four buttons: 'Send', 'Save', 'Clear', and 'Append GPS'. Below the buttons is a checkbox labeled 'Store a sent copy in SIM' which is checked.

**Note:** Message is limited to 160 characters (using 7 bit encoded default alphabets) including spaces between words. But it is limited to 70 characters per message using Unicode (UCS2) text message (such as message typed in Chinese, Japanese, etc). For sending a long SMS to another BGAN transceiver, the message is limited to 608 characters (using 7 bit encoded default alphabet) or 266 characters using Unicode (UCS2) text messages including spaces between words. If you do not wish to store a copy of the sent SMS into SIM card uncheck Store a copy in the SIM checkbox. Click Send to send the SMS.

3. Click the Send button to send the SMS.
4. To save an unsent SMS, click the Save button and the unsent SMS will be saved in Draft.
5. To clear the typed message on the text editor, click the Clear button.

---

## II. Inbox

Shows the details (Sender information, Message, Date and Time stamp) of all SMS received.

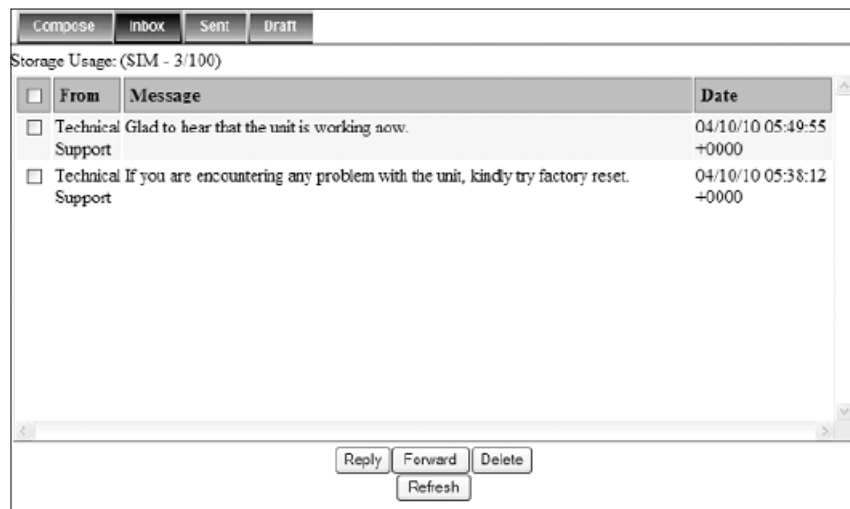

### Replying to a SMS

Follow these steps to reply a SMS:

1. Click on a SMS to select it.

The selected SMS will be highlighted in light blue.

2. Click **Reply**.

3. Click **OK** to reply with the original contents or **Cancel** to reply without the original content.

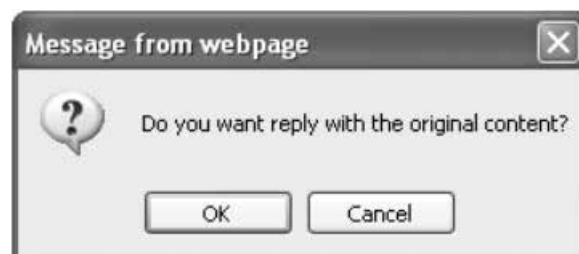

The Inbox console switches over to the Compose console.

4. Enter your reply in the text editor.

5. Click Send to send your reply SMS. The reply SMS will be sent to the recipient.

### Forwarding an SMS

Follow these steps to forward an SMS:

1. Click on a SMS to select it.  
The selected SMS will be highlighted in light blue.
2. Click **Forward**.  
The Inbox console switches over to the Compose console.
3. Enter the receiver's number in the **Phone No.** field.
4. Click **Send** to forward the SMS. The SMS will be sent to the recipient.

### Deleting a single SMS from the Inbox list

Follow these steps to delete a single SMS from the Inbox list:

1. Click on a SMS to select it.
2. Click Delete.
3. Click OK to confirm or click Cancel to abort deleting the SMS.

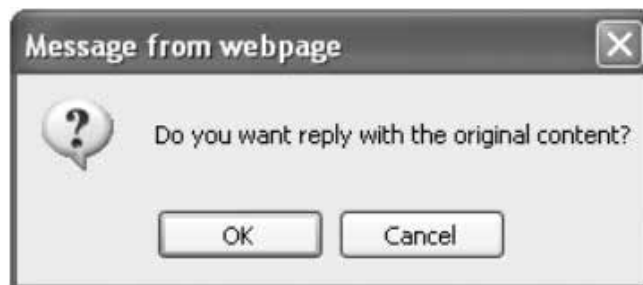

### Deleting multiple SMS from the Inbox list

Follow these steps to delete multiple SMS from the Inbox list:

1. Select the message by checking the checkboxes beside each SMS.
2. Click **Delete**.
3. Click OK to confirm the delete, or Cancel to abort the delete.
4. Click Refresh to refresh the Inbox list.



---

### III. Sent

Shows the detail (Receiver information, Message, Date and Time stamp)of all SMS sent.

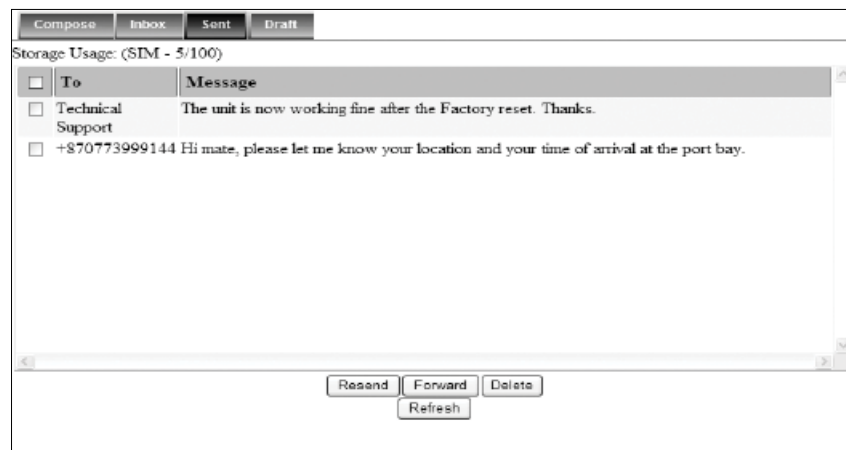

#### Resending a sent SMS

Follow these steps to resend a sent SMS (sending the same SMS to the same receiver):

1. Click on a SMS to select it.
2. Click Resend.
3. The SMS will be sent to the recipient.

### Forwarding a sent SMS

Follow these steps to forward a sent SMS to another recipient:

1. Click on a SMS to select it.
2. Click Forward.
3. The Sent console switches over to the Compose console.

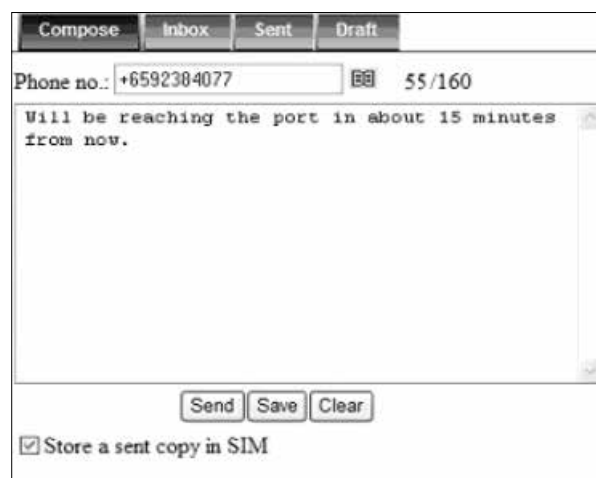

4. Enter the receiver's number in the Phone No. field.
5. Click Send. The SMS will be sent to the recipient.

### Deleting a SMS from the Sent list

Follow these steps to delete a single SMS from the Sent list:

1. Click on a SMS to select it.
2. Click Delete.
3. Click OK to confirm or click Cancel to abort deleting the SMS.

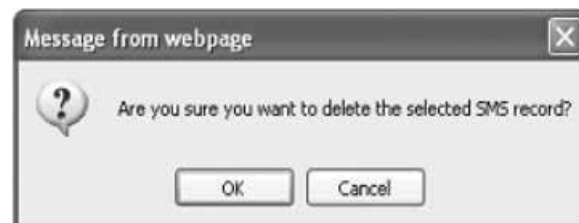

---

### Deleting multiple SMS from the Sent list

Follow these steps to delete multiple SMS from the sent list:

1. Select the message by checking the checkboxes beside each SMS.
2. Click Delete.
3. Click OK to confirm the delete, or Cancel to abort the delete.
4. Click Refresh to refresh the Sent list.

### IV. Draft

Stores SMS saved from the Compose console.



Follow these steps to send a draft SMS:

1. Click on a SMS to select it.
2. Click Send.

The SMS will be sent to the recipient.

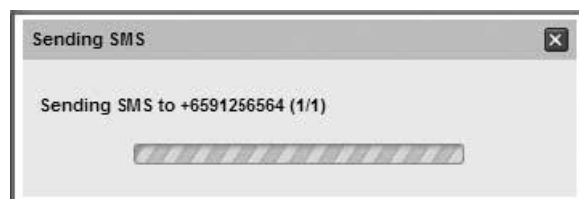

### Forwarding a draft SMS another recipient

Follow these steps to forward a draft SMS to another recipient:

1. Click on a SMS to select it.
2. Click Forward.

The Draft console switches over to the Compose console.



3. Enter the receiver's number in the Phone No. Field.
4. Click Send to forward the SMS.

The SMS will be forwarded to the recipient.

### Deleting a SMS from the Draft list

Follow these steps to delete a SMS from the Draft list:

1. Click on a SMS to select it.
2. Click **Delete**.
3. Click **OK** to confirm or click **Cancel** to abort deleting the SMS.

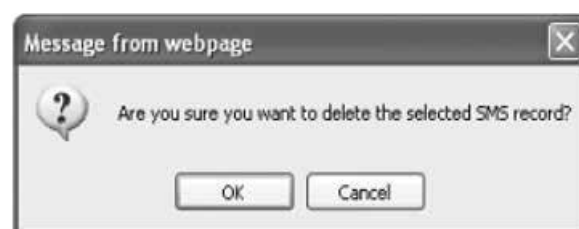

---

### Deleting multiple SMS from the Draft list

Follow these steps to delete multiple SMS from the Draft list:

1. Select the message by checking the checkboxes beside each SMS.
2. Click Delete.
3. Click OK to confirm the delete, or Cancel to abort the delete.
4. Click Refresh to refresh the Draft list.

### Data Menu



1. Click on Data icon.

Data menu provides the following options:

#### I. Connection

#### II. Primary Profiles

#### III. Secondary Profiles

#### IV. Port Forwarding

#### V. Firewall

#### VI. PPPoE

#### VII. Settings



**I. Connection**

2. To activate the default profile, click Activate Default Profile. The PDP context will be activated.

SN	APN (Access Point Name)	IP Address	Profile Name	CID	Action	Remarks
1	BGAN.INMARSAT.COM	161.30.180.5	Standard	5	<a href="#">Disconnect</a>	Primary PDP Context

[Activate Default Profile](#)

When connected, APN and the assigned public IP Address details will be displayed. You can proceed to access the Internet and use the related features.

**Activate Profile**

In progress...



Connection	Primary Profiles	Secondary Profiles	Port Forwarding	Settings
globe.bgan.inmarsat.com - 172.16.24.205 <a href="#">Disconnect</a> (Standard)				

3. To disconnect the data connection, click Disconnect. The PDP context will be deactivated.

## II. Primary Profiles

Primary profiles define the connection type.

You can select from a list of profiles to be the default primary profile and connection type. From Profile 7 to Profile 10, you can create your own customized primary profile.

The screenshot displays the 'Primary Profiles' configuration page. On the left, a list of profiles is shown, with 'Streaming32k' selected. The main configuration area includes: a 'Set as default' checkbox; a 'Profile Name' field containing 'Streaming32k'; 'Connection Type' options with 'Streaming' selected; 'Access Point Name (APN)' options with 'SIM' selected and 'BGAN.INMARSAT.COM' entered; 'IP Configuration' options with 'Dynamic IP Address' selected and 'Use Header Compression' checked; 'Streaming Parameters' with 'Desired Rate' and 'Minimum Rate' both set to '32k'; and 'Limited Connection' options with 'Time' selected. At the bottom, there are buttons for 'Update Settings', 'Cancel', and 'Activate Profile'.

**Note:** The Standard profile is set as the default primary profile and the default connection type is standard (this is charged by the volume [in kilobytes] of data used).

### Profile Name

Change the profile name as desired.

### Connection Type

Change the type of connection. By default the connection type will be standard.

**Access Point Name (APN)**

By default, the APN from the SIM will be selected.

Follow these steps to change the Access Point Name (APN):

1. Select User Defined.
2. Enter the new APN in the field space provided (e.g. BGAN inmarsat.com).
3. Enter the username and password if required.

**IP Configuration**

By default, the Dynamic IP Address is selected.

Follow these steps to use Static IP Address:

1. Select Static IP Address and enter the IP Address in the space provided.
2. Check the Header Compression checkbox if it is required to use Header Compression.

**III. Secondary Profiles**



Secondary profiles setting are used mainly for streaming connection. You may select one of the secondary profiles to be used during streaming connection. You may also create a customized secondary profile; choose from profile 7 to 10.

It also had the same time/volume limited data connection feature as the Primary Profiles.



#### IV. Port Forwarding

Port Forwarding is a feature for Router (multiple-user) mode.

This feature sets the FBB BDU to direct incoming traffic on certain TCP/UDP port to a specific port on a local PC (IP Address).

Connection	Primary Profiles	Secondary Profiles	Port Forwarding	Firewall	PPPoE	Settings
Incoming Port	Protocol	Destination IP Address	Destination Port	Enabled		
0	-	0.0.0.0	0	<input type="checkbox"/>		<a href="#">Add</a>
0	-	0.0.0.0	0	<input checked="" type="checkbox"/>		<a href="#">Add</a>
0	-	0.0.0.0	0	<input type="checkbox"/>		<a href="#">Add</a>
0	-	0.0.0.0	0	<input checked="" type="checkbox"/>		<a href="#">Add</a>
0	-	0.0.0.0	0	<input type="checkbox"/>		<a href="#">Add</a>
0	-	0.0.0.0	0	<input checked="" type="checkbox"/>		<a href="#">Add</a>
0	-	0.0.0.0	0	<input type="checkbox"/>		<a href="#">Add</a>
0	-	0.0.0.0	0	<input checked="" type="checkbox"/>		<a href="#">Add</a>
0	-	0.0.0.0	0	<input type="checkbox"/>		<a href="#">Add</a>
0	-	0.0.0.0	0	<input checked="" type="checkbox"/>		<a href="#">Add</a>

Follow these steps to add a new forwarding rule:

1. Click the Add button.

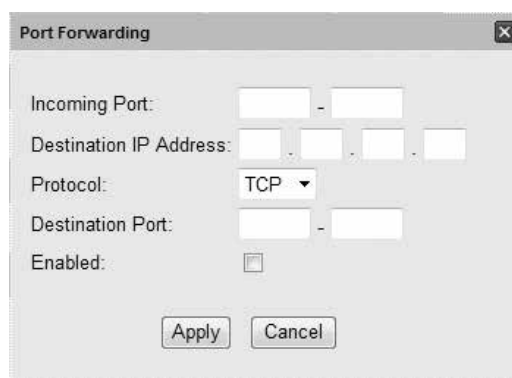

The screenshot shows a dialog box titled "Port Forwarding" with a close button (X) in the top right corner. The dialog contains the following fields and controls:

- Incoming Port:** Two input boxes separated by a hyphen.
- Destination IP Address:** Four input boxes separated by hyphens.
- Protocol:** A dropdown menu currently showing "TCP".
- Destination Port:** Two input boxes separated by a hyphen.
- Enabled:** A checkbox that is currently unchecked.
- Buttons:** "Apply" and "Cancel" buttons at the bottom.

2. Enter the Incoming Port number in the space provided.  
(For example, the user expecting HTTP traffic, the port is 80).
3. Enter the Destination IP Address.  
(For example, the IP Address of the PC that is connected to the FBB BDU).
4. Select the Protocol type TCP (e.g. for HTTP, it will be TCP) UDP.
5. Enter the Destination Port number in the space provided (For example: listening port of the particular service (for example TCP port 80 for web server) on the PC that is connected to the FBB BDU).
6. Click Apply to allow the settings to take effect.

## V. Firewall

By default, the **Firewall** is disabled.

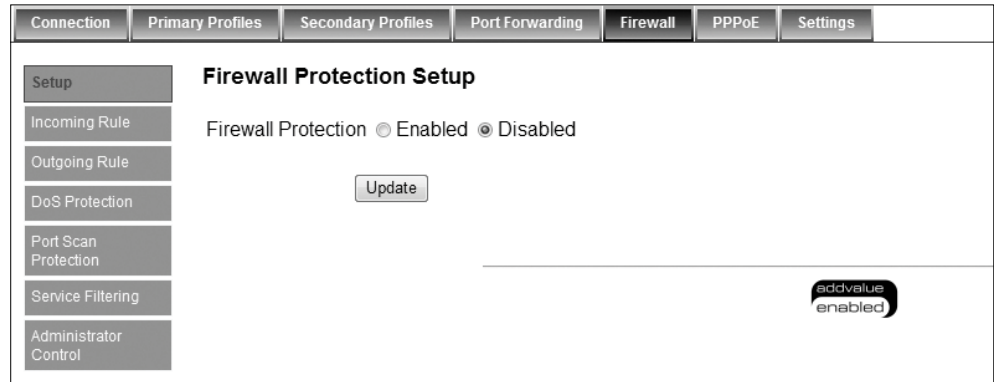

### Enable Firewall Settings

1. Navigate to **Data>Firewall>Setup** to enable Firewall protection.
2. Select **Enable**.
3. Click **Update**.



## Incoming Rule

To add and define up to 10 rules to allow or reject incoming packets.

Connection Primary Profiles Secondary Profiles Port Forwarding **Firewall** PPPoE Settings

Setup Incoming Rule **Incoming Rule** Outgoing Rule DoS Protection Port Scan Protection Service Filtering Administrator Control

Default Action for Incoming Packets  Accept  Reject

Rule Name	Protocol	Source IP Address	Source Port	Destination IP Address	Destination Port	Action	Enabled	
Default Rule	ANY	ANY	ANY	ANY	ANY	Allow	<input checked="" type="checkbox"/>	
							<input type="checkbox"/>	Add
							<input type="checkbox"/>	Add
							<input type="checkbox"/>	Add
							<input type="checkbox"/>	Add
							<input type="checkbox"/>	Add
							<input type="checkbox"/>	Add
							<input type="checkbox"/>	Add
							<input type="checkbox"/>	Add
							<input type="checkbox"/>	Add

Refresh Update

Connection Primary Profiles Secondary Profiles Port forwarding **Firewall** PPPoE Settings

Setup Incoming Rule **Incoming Rule** Outgoing Rule DoS Protection Port Scan Protection Service Filtering Administrator Control

Default Action for Incoming Packets  Accept  Reject

**Add Incoming FireWall Rule**

Rule Name: Rule 1

Protocol:  TCP  UDP  ICMP  ANY

Source IP Address: 1 . 1 . 1 . 1 - 1 . 1 . 1 . 1

Source Port: 0 - 0

Destination IP Address: 0 . 0 . 0 . 0 - 0 . 0 . 0 . 0

Destination Port: 0 - 0

Action:  Allow  Reject

Enabled:

Apply Cancel

Note: IP Addresses, Ports with value 0 means ANY.  
eg. IP (0.0.0.0 - 0.0.0.0) means ANY IP. Port (0 - 0) means ANY Port.

Rule Name	Protocol	Source IP Address	Source Port	Destination IP Address	Destination Port	Action	Enabled	
Default Rule	ANY	ANY	ANY	ANY	ANY	Allow	<input checked="" type="checkbox"/>	
							<input type="checkbox"/>	Add
							<input type="checkbox"/>	Add
							<input type="checkbox"/>	Add
							<input type="checkbox"/>	Add
							<input type="checkbox"/>	Add
							<input type="checkbox"/>	Add
							<input type="checkbox"/>	Add
							<input type="checkbox"/>	Add
							<input type="checkbox"/>	Add

Refresh Update

### Outgoing Rule

To add and define up to 10 rules to allow or reject outgoing packets.

Outgoing Rule

Default Action for Outgoing Packets:  Accept  Reject

Rule Name	Protocol	Source IP Address	Source Port	Destination IP Address	Destination Port	Action	Enabled	
Default Rule	ANY	ANY	ANY	ANY	ANY	Allow	<input checked="" type="checkbox"/>	
							<input type="checkbox"/>	Add
							<input type="checkbox"/>	Add
							<input type="checkbox"/>	Add
							<input type="checkbox"/>	Add
							<input type="checkbox"/>	Add
							<input type="checkbox"/>	Add
							<input type="checkbox"/>	Add
							<input type="checkbox"/>	Add

Refresh Update

Outgoing Rule

Default Action for Outgoing Packets:  Accept  Reject

Add Outgoing Firewall Rule

Rule Name	Protocol	Source IP Address	Source Port	Destination IP Address	Destination Port	Action	Enabled	
Default Rule	ANY					ANY	Allow	<input checked="" type="checkbox"/>
							<input type="checkbox"/>	Add
							<input type="checkbox"/>	Add
							<input type="checkbox"/>	Add
							<input type="checkbox"/>	Add
							<input type="checkbox"/>	Add
							<input type="checkbox"/>	Add
							<input type="checkbox"/>	Add
							<input type="checkbox"/>	Add

Note: IP Addresses, Ports with value 0 means ANY.  
eg. IP (0.0.0.0 - 0.0.0.0) means ANY IP, Port (0 - 0) means ANY Port.

Apply Cancel

Refresh Update

## DoS Protection

To add to enable block packets from public network. By default, the DoS is disabled.

Connection	Primary Profiles	Secondary Profiles	Port Forwarding	Firewall	PPPoE	Settings
Setup	<b>DoS Protection</b>					
Incoming Rule	Status <input type="radio"/> Enabled <input checked="" type="radio"/> Disabled					
Outgoing Rule						
DoS Protection	<b>Block packets with spoofed source IP addresses from public network</b>					
Port Scan Protection	<input type="checkbox"/> Block packets from Historical Broadcast addresses (0.0.0.0/8)					
Service Filtering	<input type="checkbox"/> Block packets from Unallocated and Broadcast addresses (248.0.0.0/5)					
Administrator Control	<input type="checkbox"/> Block packets from RFC 1918 Class A private addresses (10.0.0.0/8)					
	<input type="checkbox"/> Block packets from RFC 1918 Class B private addresses (172.16.0.0/12)					
	<input type="checkbox"/> Block packets from RFC 1918 Class C private addresses (192.168.0.0/16)					
	<input type="checkbox"/> Block packets from Class D Multicast addresses (224.0.0.0/4)					
	<input type="checkbox"/> Block packets from Class E Reserved addresses (240.0.0.0/5)					
	<input type="checkbox"/> Block packets from Link Local addresses (169.254.0.0/16)					
	<input type="checkbox"/> Block packets from TEST-NET addresses (192.0.2.0/24)					
	<input type="checkbox"/> Block packets claiming to be from our own private network					
	<input type="checkbox"/> Block packets claiming to be from UT's public address					
	<b>Block broadcast packets from public network</b>					
	<input type="checkbox"/> Block packets (sent) to limited broadcast address (255.255.255.255/32)					
	<input type="checkbox"/> Block packets (sent) to public network broadcast address					
	<input type="button" value="Update"/>					

## Port Scan Protection

To enable block other packets from public network. By default, the Port Scan Protection is disabled.

Connection	Primary Profiles	Secondary Profiles	Port Forwarding	Firewall	PPPoE	Settings
Setup	<b>Port Scan Protection</b>					
Incoming Rule	Status <input type="radio"/> Enabled <input checked="" type="radio"/> Disabled					
Outgoing Rule						
DoS Protection	<b>Block packets with illegal TCP flags or illegal TCP flag combinations from public network</b>					
Port Scan Protection	<input type="checkbox"/> Block packets with all flags set - XMAS Scan					
Service Filtering	<input type="checkbox"/> Block packets with no flags set - NULL Scan					
Administrator Control	<input type="checkbox"/> Block packets with SYN and FIN set					
	<input type="checkbox"/> Block packets with SYN and RST set					
	<input type="checkbox"/> Block packets with FIN and RST set					
	<input type="checkbox"/> Block packets with FIN set, but ACK not set					
	<input type="checkbox"/> Block packets with PUSH set, but ACK not set					
	<input type="checkbox"/> Block packets with URG set, but ACK not set					
	<input type="button" value="Update"/>					

### Service Filtering

To prevent external network accessing your terminal. By default, the Service Filtering is disabled.

Connection	Primary Profiles	Secondary Profiles	Port Forwarding	Firewall	PPPoE	Settings
Setup	<b>Service Filtering</b>					
Incoming Rule	Status <input type="radio"/> Enabled <input checked="" type="radio"/> Disabled					
Outgoing Rule	<b>Select the following service(s) if you would like to block it</b>					
DoS Protection	<input type="checkbox"/> Ping from External Network					
Port Scan Protection	<input type="checkbox"/> Telnet from External Network					
<b>Service Filtering</b>	<input type="checkbox"/> Access webconsole from External Network					
Administrator Control	<input type="checkbox"/> Access AT command service from External Network					
	<input type="button" value="Update"/>					

## Administrator Control

To block any keyword in the content of the accessing page.

The screenshot shows a web interface with a navigation bar at the top containing tabs: Connection, Primary Profiles, Secondary Profiles, Port Forwarding, Firewall, PPPoE, and Settings. The 'Administrator Control' section is active in the left sidebar. The main content area is titled 'Keyword Block' and contains the following elements:

- Block website access based on keywords specified below**
- Enable Keyword Block
- Enter Keyword:
- Blocked Keyword(s)
- 

## VI. PPPoE

By default, the PPPoE is disabled.

The screenshot shows a web interface with a navigation bar at the top containing tabs: Connection, Primary Profiles, Secondary Profiles, Port Forwarding, Firewall, PPPoE, and Settings. The 'PPPoE Setup' section is active in the left sidebar. The main content area contains the following elements:

- PPPoE Setup**
- PPPoE  Enabled  Disabled
- 
- Note: Changes only take effect after terminal reboots.

1. Select Enable.
2. Click Update.
3. Once the PPPoE service is enabled, a pop-up message box indicates the PPPoE service is activated and requires rebooting of terminal for the service to take effect

## VII. Setting

You can select the Ethernet mode to be used for data connection.

Connection	Primary Profiles	Secondary Profiles	Port Forwarding	Firewall	PPPoE	Settings
<p><b>Ethernet mode:</b></p> <p> <input type="radio"/> Router Mode (Single User)  <input checked="" type="radio"/> Router Mode (Multi-User)  <input checked="" type="checkbox"/> Always On (Auto PDP Context Activation)                 </p> <p><b>Default Primary Profile:</b> <a href="#">Standard</a></p> <p style="text-align: center;"> <input type="button" value="Update"/> <input type="button" value="Refresh"/> </p>						

Follow these steps to select the Ethernet mode:

1. Select the desired mode to be used during the data connection:
  - Router (Single User) is with NAT/PAT disabled.
  - Router (Multi-User) is with NAT/PAT enabled for multi-user.

**Note:** You cannot change the Router settings while a Data connection is active, you must first disconnect your Data session.

2. Check “Always On (Auto PDP Context Activation)” if required.
3. Click Update to allow the selection to take effect.
4. Click **Refresh** to query the current mode.



---

## Settings Menu



1. Click on Settings icon.  
Setting menu provides the following options:

- I. Language**
- II. Terminal Info**
- III. Ethernet**
- IV. Telephony**
- V. PIN**
- VI. SMS**
- VII. Wi-Fi**
- VIII. Tracking**
- IX. Admin**
- X. Support**
- XI. Accounts**
- XII. About**

### I. Language

Select the desired language for the Web Console to be displayed. (Spanish, Chinese-Simplified and Chinese-Traditional may not be an option that is available at the time of purchase).

Language	Terminal Info	Ethernet	Telephony	PIN	SMS	Wi-Fi	Tracking	Admin	Support	Accounts	About
<ul style="list-style-type: none"><li><input checked="" type="radio"/> English</li><li><input type="radio"/> 简体中文</li><li><input type="radio"/> 繁體中文</li><li><input type="radio"/> Español</li><li><input type="radio"/> Nederlands</li></ul> <p>Apply</p>											

## II. Terminal Info

This tab shows general information about the UE, Error/Event Logos and Call Logs.

### Information

Displays information about the Manufacture ID, Software version, Model ID, IMEI number, IMSI number (only when a SIM card is inserted), Subscriber number and Antenna Unit's serial number.

Language	Terminal Info	Ethernet	Telephony	PIN	SMS	Tracking	Admin	Support	Accounts	About
Information										
Logs										
Call Log										
Call/Data Usage										
	<b>Manufacture ID:</b>	Addvalue								
	<b>Software Version:</b>	R01.6.1								
	<b>Hardware Version:</b>	2								
	<b>Model ID:</b>	FB500								
	<b>IMEI Number:</b>	352680050000036								
	<b>IMSI Number:</b>	901112114169995								
	<b>Subscriber Number:</b>	Not available								
	<b>BDU Serial Number:</b>	MB5001A121300004								
	<b>MAC Address:</b>	00:0B:68:01:59:4C								

### Logs

Displays event and error logs of the UE.

Language	Terminal Info	Ethernet	Telephony	PIN	SMS	Tracking	Admin	Support	Accounts	About
Information										
Logs										
Call Log										
Call/Data Usage										
	Log Type: <input type="text" value="Event"/>									
		<b>Date/Time</b>	<b>Logs</b>							
		Fri Jan 27 2012, 23:25:19 -0800	Primary PDP context activation succeeded 5[5]							
		Fri Jan 27 2012, 23:25:13 -0800	UE initiated a Primary PDP context activation 5[5]							
		Fri Jan 27 2012, 22:25:42 -0800	Call has ended							
		Fri Jan 27 2012, 22:24:34 -0800	Outgoing call in progress							
		Fri Jan 27 2012, 22:23:56 -0800	Call has ended							
		Fri Jan 27 2012, 22:23:13 -0800	Outgoing call in progress							
		Fri Jan 27 2012, 21:58:29 -0800	Combined Attach Success							
		<input type="button" value="Delete All"/> <input type="button" value="Export All Logs"/>								

---

### Call Log

Displays the call history including standard voice calls, high-quality / fax calls, standard data sessions.

Language	Terminal Info	Ethernet	Telephony	PIN	SMS	Tracking	Admin	Support	Accounts	About
Information	PIN <input type="text"/>									
Logs	<input type="button" value="Retreive"/>									
Call Log										
Call/Data Usage										

### Call / Data Usage

Displays the total call usage and total data usage.

Click clear to reset counter.

Language	Terminal Info	Ethernet	Telephony	PIN	SMS	Tracking	Admin	Support	Accounts	About
Information	Total Call Usage: 00:00:00		<input type="button" value="Clear"/>							
Logs	Total Data Usage: 0 byte		<input type="button" value="Clear"/>							
Call Log										
Call/Data Usage										

### III. Ethernet

1. Click Ethernet to view and edit the Ethernet settings.
2. Click Update to allow the settings to take effect.

Language	Terminal Info	Ethernet	Telephony	PIN	SMS	Tracking	Admin	Support	Accounts	About
Ethernet	Terminal IP Address: <input type="text" value="192"/> . <input type="text" value="168"/> . <input type="text" value="1"/> . <input type="text" value="35"/>									
DHCP	Terminal Subnet Mask: <input type="text" value="255"/> . <input type="text" value="255"/> . <input type="text" value="255"/> . <input type="text" value="0"/>									
MAC Filtering	<input type="button" value="Update"/>									

### DHCP

1. Click **DHCP** to view and edit the DHCP settings.
2. Click **Update** to allow the settings to take effect.

Language	Terminal Info	Ethernet	Telephony	PIN	SMS	Tracking	Admin	Support	Accounts	About	
		Ethernet	DHCP: <input checked="" type="radio"/> Enabled <input type="radio"/> Disabled								
		DHCP	Primary DNS: 8 . 8 . 8 . 8								
		MAC Filtering	Secondary DNS: 8 . 8 . 4 . 4								
			DHCP IP Pool Start: 192 . 168 . 1 . 40								
			DHCP IP Pool End: 192 . 168 . 1 . 59								
			IP Lease Time: 0 second(s)								
			<input type="button" value="Update"/>								

### Mac Address Filtering

1. Click Mac Filtering to view and edit the Mac Filtering settings.
2. Click Update to allow the settings to take effect.

Language	Terminal Info	Ethernet	Telephony	PIN	SMS	Tracking	Admin	Support	Accounts	About	
		Ethernet	MAC Filtering: <input checked="" type="radio"/> Enabled <input type="radio"/> Disabled								
		DHCP	Use: <input checked="" type="radio"/> Reject List <input type="radio"/> Allowed List								
		MAC Filtering	<input type="button" value="Update"/>								
			<b>Reject List</b>								
			11.22.33.44.55.66 <input type="button" value="Delete"/>								
			<input type="text"/> <input type="button" value="Add"/>								
			<input type="button" value="Delete All"/>								
			*Your MAC Address: 98:76:54:32:10:12								

### Reject List

All PCs/Laptops will be allowed to access the TU except for those (MAC addresses) listed in the Reject List.

### Allow List

All PCs/Laptops will be denied access to the TU except for those (MAC addresses) listed in the Allow List. When selecting this list, at least one entry should be there to access the TU.

## IV. Telephony

Language	Terminal Info	Ethernet	Telephony	PIN	SMS	Tracking	Admin	Support	Accounts	About
Interface	Telephone Interface Configurations: US Caller Line ID Phone connected									
Port Configuration	<input type="button" value="Update"/>									
Caller ID										
Call Waiting										
Call Barring										
Call Forwarding										
Call Restriction										

### Interface

1. Select European Caller Line ID Phone connected or US Caller Line ID Phone connected from the Telephone Interface Configuration drop-down menu.
2. Click Update to allow the setting to take effect.

### Port Configuration

For each of the 3 ports, a choice of the quality calls can be selected. Select your ideal call quality and click **Update**.

### Primary Handset

Port	Call Type	Service Type	Enable External Ringing?	
Primary Handset	Incoming Call	Standard voice call Standard voice call	<input type="checkbox"/>	<a href="#">Update</a>
	Outgoing Call	None Standard voice call		<a href="#">Update</a>

### Phone Port

PHONE Port	Incoming Call	Standard voice call	<input type="checkbox"/>	<a href="#">Update</a>
	Outgoing Call	Standard voice call		<a href="#">Update</a>

### Fax Port

For the fax port, if no subscription is made, there will be no choices.

FAX Port	Incoming Call	None ▾	<input type="checkbox"/>	<a href="#">Update</a>
	Outgoing Call	None ▾		<a href="#">Update</a>

If fax subscription is made, 3.1 KHz high quality fax call will be available.

FAX Port	Incoming Call	3.1kHz high quality voice/fax call ▾ 3.1kHz high quality voice/fax call None		<a href="#">Update</a>
	Outgoing Call	3.1kHz high quality voice/fax call ▾ 3.1kHz high quality voice/fax call None		<a href="#">Update</a>

### Caller ID

1. Click **Retrieve** to get current setting of the **Allow called party to see your number configuration**.
2. To change the setting, select **Yes**, **No**, or **According to network subscription** for the **Allow called party to see your number configuration**.
3. Click **Apply** to allow the setting to take effect.

Language	Terminal Info	Ethernet	Telephony	PIN	SMS	Tracking	Admin	Support	Accounts	About
Interface	Port Configuration	Caller ID	Call Waiting	Call Barring	Call Forwarding	Call Restriction				
<b>Allow called party to see your number?</b> <input type="radio"/> Yes <input type="radio"/> No <input type="radio"/> According to network subscription										
<input type="button" value="Retrieve"/> <input type="button" value="Apply"/>										

---

## Call Waiting

1. Click **Retrieve** to get current setting of the **Enable call-waiting** configuration.
2. To change the setting, select **Yes** or **No** for the **Enable call waiting** configuration.
3. Click **Apply** to allow the new setting to take effect.

The screenshot shows a web interface with a navigation menu at the top containing: Language, Terminal Info, Ethernet, Telephony, PIN, SMS, Tracking, Admin, Support, Accounts, and About. The 'Telephony' menu item is selected. On the left, a sidebar lists configuration options: Interface, Port Configuration, Caller ID, Call Waiting, Call Barring, Call Forwarding, and Call Restriction. The 'Call Waiting' option is highlighted. The main content area is titled 'Enable call waiting?' and contains two radio buttons: 'Yes' and 'No'. Below the radio buttons are two buttons: 'Retrieve' and 'Apply'.

## Call Barring

1. Click any individual **Retrieve** option to get the current setting of the corresponding scenario in which the calls would be barred.
2. Select the scenario in which the calls would be barred, or deselect the scenario to disable the corresponding call barring.
3. In the **Barring PIN** field, input a PIN for call barring setup.
4. Click **Apply** to allow the corresponding setting to take effect.
5. Clicking **Retrieve All** will retrieve the current settings of all four call barring scenarios at the same time.
6. Clicking **Apply All** will allow the settings of all four call barring scenarios to take effect at the same time.

The screenshot shows the same web interface as above, but with the 'Call Barring' option highlighted in the sidebar. The main content area displays four scenarios with checkboxes: 'Bar all outgoing calls', 'Bar all outgoing international calls except those directed to the home country', 'Bar all incoming calls when roaming outside the home country', and 'Bar all incoming calls'. To the right of these scenarios is a 'Barring PIN' field with a text input box. Below the scenarios are two buttons: 'Retrieve All' and 'Apply All'. For each scenario, there are 'Retrieve' and 'Apply' buttons.

**Call forwarding**

1. Click any individual **Retrieve** option to get current setting of the corresponding scenario in which incoming calls would be forwarded.
2. Select the scenario in which the calls should be forwarded, or deselect the scenario to disable the corresponding call forwarding setting.
3. In the **Divert to Number** field, input the phone number where the incoming calls should be forwarded to (+<country code><telephone number>).
4. If the **Divert if not answered** option is selected, select from the **Divert After (seconds)** drop-down list, the period of time the network should wait before forwarding the calls.
5. Click **Apply** to allow the setting to take effect.
6. Clicking **Retrieve All** will retrieve the current settings of all four scenarios in which the calls would be forwarded, at the same time.
7. Clicking **Apply All** will allow the settings of all four scenarios to take effect at the same time.

Language	Terminal Info	Ethernet	Telephony	PIN	SMS	Tracking	Admin	Support	Accounts	About
Interface			<b>Divert To Number</b>	<b>Divert After (seconds)</b>						
Port Configuration	<input type="checkbox"/> Divert all calls		<input type="text"/>					<a href="#">Retrieve</a>	<a href="#">Apply</a>	
Caller ID	<input type="checkbox"/> Divert if busy		<input type="text"/>					<a href="#">Retrieve</a>	<a href="#">Apply</a>	
Call Waiting	<input type="checkbox"/> Divert if not answered		<input type="text"/>	30	▼			<a href="#">Retrieve</a>	<a href="#">Apply</a>	
Call Barring	<input type="checkbox"/> Divert if out of reach		<input type="text"/>					<a href="#">Retrieve</a>	<a href="#">Apply</a>	
Call Forwarding										
Call Restriction										
<input type="button" value="Retrieve All"/> <input type="button" value="Apply All"/>										



---

## Call Restriction

The Call Restriction is only enabled for outgoing call.

There are 2 types of restriction:

1. Phonebook - The user is only able to make outgoing calls from the phonebook list.
2. Call List - In this segment, it further categorised into Allowed List and Blocked List for the 3 types of telephony functions.

**a. Allowed List** - The administrator can either enter the telephone numbers or simply the country and/or area code to limit other users to make outgoing calls. If the administrator can only enter one number or country code, users can only call this number or within the country.

**b. Blocked List** - Similar to the Allowed List, once the number or country and/or area code is entered, users are unable to make any outgoing calls through the number or within the country and/or area code specified in the list.

I. Select **Enabled** or **Disabled** to activate or deactivate call restriction respectively.

II. Select **Call List** or **Phonebook** to choose which directory you want to be restricted by.

III. Select **Allowed List** or **Blocked List** for each of the 3 ports to choose if that particular port numbers are the allowed or block list.

The screenshot shows a web interface with a navigation bar at the top containing tabs: Language, Terminal Info, Ethernet, Telephony, PIN, SMS, Tracking, Admin, Support, Accounts, and About. The 'Telephony' tab is selected. On the left, a sidebar menu lists: Interface, Port Configuration, Caller ID, Call Waiting, Call Barring, Call Forwarding, and Call Restriction. The 'Call Restriction' section is active and contains the following configuration options:

- Call Restriction:**  Enabled  Disabled
- Restrict By:**  Call List  Phonebook
- Primary Handset:** Use as  Allowed List  Blocked List
  - 0234567890
  - 10234567890
  - 1234567890
  - 11234567890
  - 2234567890
  - 12234567890
- RJ11 PHONE Port:** Use as  Allowed List  Blocked List
  - 0234567890
  - 10234567890
  - 1234567890
  - 11234567890
  - 2234567890
  - 12234567890
- RJ11 FAX Port:** Use as  Allowed List  Blocked List
  - 0234567890
  - 10234567890
  - 1234567890
  - 11234567890
  - 2234567890
  - 12234567890

## V. PIN

### Terminal PIN

1. Click Transceiver PIN to configure the Transceiver PIN settings.
2. Select **Disabled** if you do not need to set the Transceiver PIN.
3. Select **Enabled** to set the Transceiver PIN.
4. Enter the PIN number in the Enter PIN field and click **Update PIN**.

Follow these steps to change the Transceiver PIN:

1. Enter the old PIN number in the Enter Old PIN field.
2. Enter the new PIN number in the Enter New PIN field.
3. Re-enter the new PIN number in the Re-enter New PIN field.
4. Click Change PIN Password.

The Transceiver PIN is now changed.

**Note:** The default Transceiver PIN is “0000”

Language	Terminal Info	Ethernet	Telephony	PIN	SMS	Tracking	Admin	Support	Accounts	About
<div style="border: 1px solid gray; padding: 2px; margin-bottom: 2px;">Terminal PIN</div> <div style="border: 1px solid gray; padding: 2px; margin-bottom: 2px;">SIM PIN</div> <div style="border: 1px solid gray; padding: 2px;">SIM PIN2</div>		<p><b>Terminal PIN</b></p> <p> <input checked="" type="radio"/> Enabled                     <input type="radio"/> Disabled                 </p> <p>Enter PIN: <input style="width: 100px;" type="text"/></p> <p style="text-align: center;"><input type="button" value="Apply"/></p> <p><b>Change PIN Password:</b></p> <p>Enter Old PIN: <input style="width: 100px;" type="text"/></p> <p>Enter New PIN: <input style="width: 100px;" type="text"/></p> <p>Re-enter New PIN: <input style="width: 100px;" type="text"/></p> <p style="text-align: center;"><input type="button" value="Change PIN Password"/></p>								

---

## SIM PIN

1. Click SIM PIN to configure the SIM PIN settings.
2. Select Disabled if you do not need to set the SIM PIN.
3. Select Enabled to set the SIM PIN.
4. Enter the PIN number in the space provided and click Update PIN.

**Note:** The SIM PIN depends on the SIM card. Consult your equipment distributor if necessary.

Language	Terminal Info	Ethernet	Telephony	<b>PIN</b>	SMS	Tracking	Admin	Support	Accounts	About
----------	---------------	----------	-----------	------------	-----	----------	-------	---------	----------	-------

Terminal PIN	<b>SIM PIN</b>
SIM PIN	<input checked="" type="radio"/> Enabled <input type="radio"/> Disabled
SIM PIN2	Enter PIN: <input type="text"/>
	<input type="button" value="Apply"/>
	<b>Change PIN Password:</b>
	Enter Old PIN: <input type="text"/>
	Enter New PIN: <input type="text"/>
	Re-enter New PIN: <input type="text"/>
	<input type="button" value="Change PIN Password"/>

### SIM PIN2

1. Click SIM PIN2 to configure the SIM PIN2 settings.
2. Select **Disabled** if you do not need to set the SIM PIN2.
3. Select **Enabled** to set the SIM PIN2.
4. Enter the PIN number in the space provided and click **Update PIN**.

Follow these steps to change the PIN Password:

1. Enter the old PIN number in the Enter Old PIN field.
2. Enter the new PIN number in the Enter New PIN field.
3. Re-enter the new PIN number in the Re-enter New PIN field.
4. Click Change PIN Password.
5. The Transceiver PIN is now changed.

**Note:** The SIM PIN2 depends on the SIM card. Consult your equipment distributor if necessary.

The screenshot shows a web interface with a navigation bar at the top containing tabs for Language, Terminal Info, Ethernet, Telephony, PIN, SMS, Tracking, Admin, Support, Accounts, and About. The 'PIN' tab is selected. On the left, there are three menu items: Terminal PIN, SIM PIN, and SIM PIN2. The main content area is titled 'SIM PIN2' and contains two sections. The first section has radio buttons for 'Enabled' (selected) and 'Disabled'. Below this is a text input field labeled 'Enter PIN:' with an 'Apply' button underneath. The second section is titled 'Change PIN Password:' and contains three text input fields labeled 'Enter Old PIN:', 'Enter New PIN:', and 'Re-enter New PIN:'. A 'Change PIN Password' button is located at the bottom of this section.

### VI. SMS

To change the SMS service Center Address number, enter the new number in the space provided and click Update.

The screenshot shows a web interface with a navigation bar at the top containing tabs for Language, Terminal Info, Ethernet, Telephony, PIN, SMS, Tracking, Admin, Support, Accounts, and About. The 'SMS' tab is selected. On the left, there are two menu items: Setup and Remote Control. The main content area is titled 'Service Center Address' and contains two radio buttons: 'SIM' (selected) and 'User Defined'. Below the 'SIM' radio button is a text input field containing the number '+870772001799'. Below the 'User Defined' radio button is a text input field containing the number '+882161900000'. An 'Update' button is located at the bottom of the form.

**Note:** Please contact your distributor or service provider if you do not know the Service Center Address.

---

## VII. Wi-Fi

By default, the Wi-Fi is disabled.

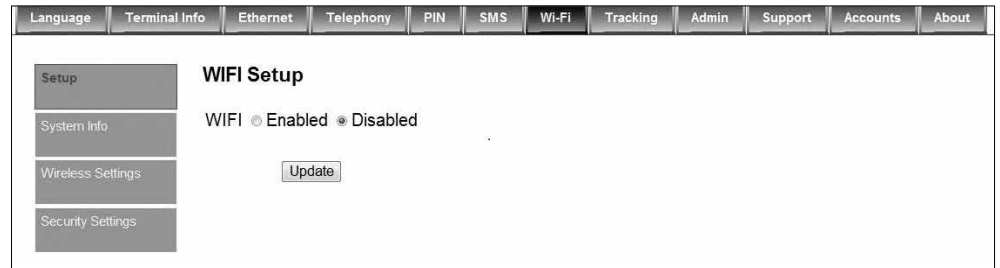

1. Select Enabled to turn on the Wi-Fi module.  
(Go to Wireless Setting to enable Wi-Fi to be accessible by other devices.)
2. Click Update.
3. Once the Wi-Fi service is enabled, a pop-up message box indicates the Wi-Fi service is activated.

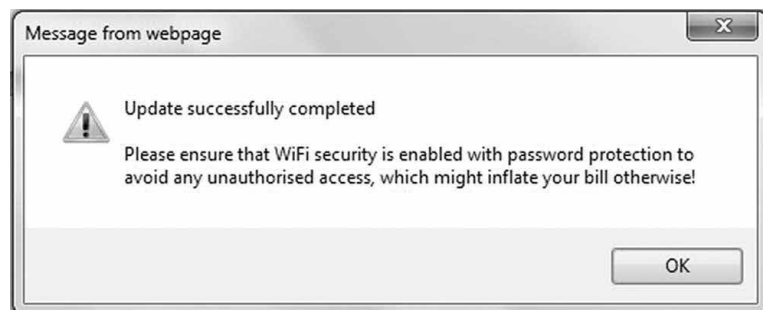

## System Info

Shows you software version and MAC address.



### Wireless Settings

1. Select Enabled to allow the WI-Fi network access to Wi-Fi enabled devices.
2. Choose ideal network mode, channel bandwidth and channel.
3. If required, Network Name can be renamed by user.

Language Terminal Info Ethernet Telephony PIN SMS Wi-Fi Tracking Admin Support Accounts About

Setup System Info **Wireless Settings** Security Settings

**Wireless Settings:**  Enabled  Disabled  
**Network Mode:** 802.11g  
**Network Name (SSID):** Wideye-GenericAP  
 Allow SSID Broadcast  
**Channel Bandwidth:** 20Mhz  
**Channel:** 1

Update

### Security Settings

Follow the steps to configure the security settings of the Wi-Fi module.

1. Select the security mode and authentication key.

**Note:** There are four sets of security passwords available for your security configuration and you can only select one set of password.

2. Select the default key to enable the desire password from Key 1 to Key 4 respectively.

Language Terminal Info Ethernet Telephony PIN SMS Wi-Fi Tracking Admin Support Accounts About

Setup System Info Wireless Settings **Security Settings**

**Security Mode:** WEP  
**Authentication Type:** Open Key  
**Default Key:** 1  
**Key 1:** 12345678901234567890123456  
**Key 2:**  
**Key 3:**  
**Key 4:**

Update

**WEP Key Instructions:**  
Enter 10 hex characters for 40/64 bits security.  
Enter 26 hex character for 108/128 bits security.  
Valid hex characters are digit 0 through 9 and letters A through F.

## VIII. Tracking Settings

1. Select Disabled if you do not need GPS reporting.
2. Select Enabled if you need GPS reporting.
3. Select either IP Data or SMS mode.
4. Key in the desire frequency in seconds. (The time interval to update the server.)
5. Key in the server phone number (SMS mode only).
6. Key in the server IP address (IP Data mode only).
7. Key in server Port number (IP Data mode only).
8. Server Connection type is fixed to TCP (IP Data mode only).
9. Key in the Distance interval.
10. Key in the speed limit alarm.
11. Key in 3 authorized phone numbers (SMS mode only).
12. Key in number of Retries when the alert fails to send out due to unexpected error.

Language	Terminal Info	Ethernet	Telephony	PIN	SMS	Tracking	Admin	Support	Accounts	About
Settings										
Geo Fence										
APN (Access Point Name)										
	GPS Reporting:			<input type="radio"/> Enabled <input checked="" type="radio"/> Disabled						
	Mode:			IP Data ▾						
	Tracking ID:			E70Q0t						
	Frequency:			1800						
	Server Phone Number:									
	Server IP Address:									
	Server Port:			0						
	Server Connection Type:			TCP ▾						
	Distance Interval:			0		m				
	Speed Limit (Alarm):			0		km/h				
	Authorized Phone Number (1/3):									
	Authorized Phone Number (2/3):									
	Authorized Phone Number (3/3):									
	Number of Retries:			2		(0 - 255)				
<input type="button" value="Update"/>										

### Geo Fence

1. There are two ways to enter latitude/longitude:
  - a) Degrees, minutes, seconds.
  - b) Decimal degrees.
2. Select the desired latitude/longitude format.
3. Click the Add.
4. Select the alarm trigger type:
  - a) In
  - b) Out
  - c) In and Out
5. Select the type of Geo Fence:
  - a) Circle (1 points, radius)
  - b) Rectangle (2 points)
  - c) Polygon (minimum 3 points. maximum 10 points)
6. Key in the Latitude and Longitude values. Click Apply to confirm.

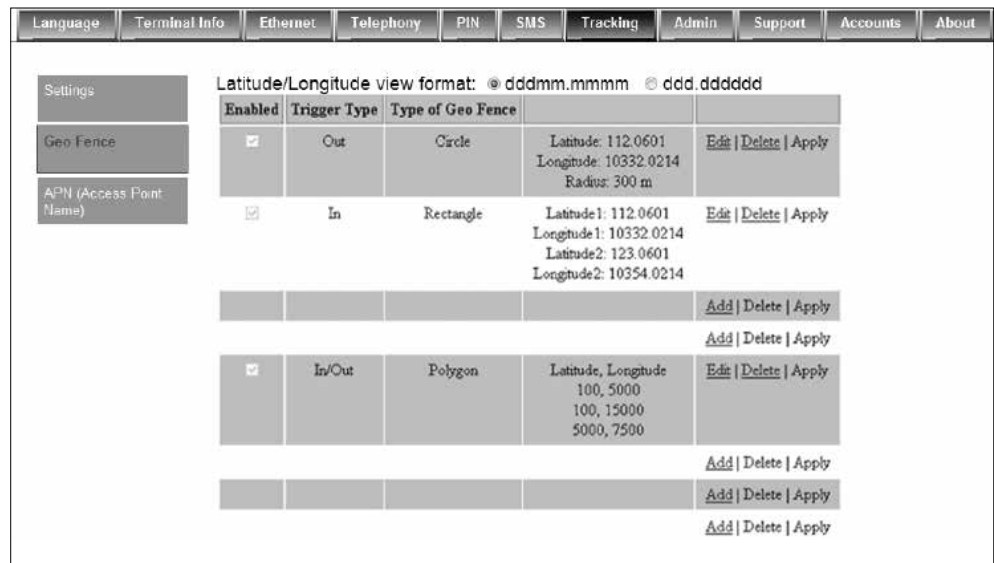



### APN (Access Point Name)

This APN is configured to channel the tracking data traffic unlike the APN defined under DATA> Primary profile which is used for user data traffic such as Web browsing, FTP, Email etc.

By default, the SIM is selected which mean the APN stored in the Sim card will be used for the tracking function.

Follow these steps to change the Access Point Name (APN):

1. Select User Defined.
2. Enter the new APN in the field space provided (e.g. BGAN-AU.INMARSAT.COM).
3. Enter the username and password if required.

Language	Terminal Info	Ethernet	Telephony	PIN	SMS	Tracking	Admin	Support	Accounts	About
Settings	<b>Access Point Name (APN):</b>									
Geo Fence	<input checked="" type="radio"/> SIM      BGAN.INMARSAT.COM									
APN (Access Point Name)	<input type="radio"/> User Defined <input type="text"/>									
	Username: <input type="text"/>									
	Password: <input type="text"/>									
	<input type="button" value="Update"/>									

## IX. Admin

### Change Password

Follow these steps to change the Web Console login Password:

1. Enter the old password in the Old Password field.
2. Enter the new password in the New Password field.
3. Re-enter the new password in the Re-type Password field.
4. Click Update.
5. The Web Console login password is now changed.

Language	Terminal Info	Ethernet	Telephony	PIN	SMS	Tracking	Admin	Support	Accounts	About
Change Password	Old Password: <input type="text"/>									
Firmware Upgrade	New Password: <input type="text"/>									
Reboot Terminal	Re-type Password: <input type="text"/>									
Factory Reset	<input type="button" value="Update"/>									
Save Settings										
GPS Output										
Ciphering										
Remote Access										
Backup/Restore										
Feature										

### Firmware Upgrade

Firmware upgrade is to update your FBB BDU with the latest firmware. Please refer to your respective distributor for your firmware download.

**Warning: DO NOT abort the upgrading process or unplug the power of the FBB BDU during the firmware upgrade process at any time. Doing so will corrupt the existing firmware loaded onto the FBB BDU.**

Follow these steps to upgrade the firmware for your FBB BDU:

1. Download or acquire the new firmware from your respective distributor and save it in your computer's hard drive.

**Note:** Make sure the FBB BDU is switched on and connected to the desktop/laptop computer using the LAN cable.

2. Select Firmware Upgrade.

Read the Disclaimer message carefully before proceeding with the Firmware Upgrade.

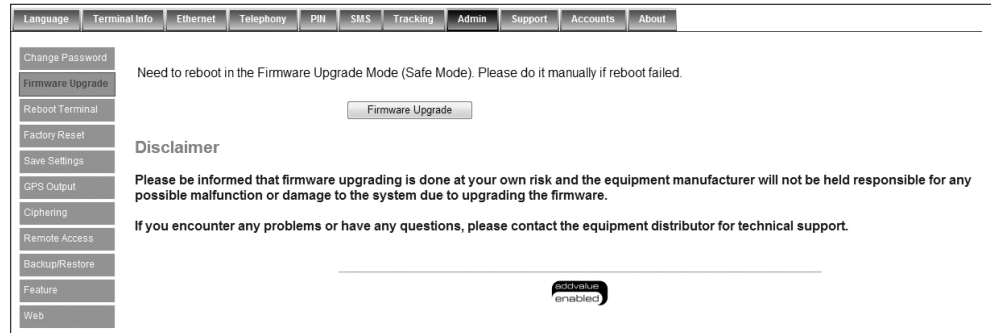

3. Click **Firmware Upgrade**.

The FBB BDU will reboot into Safe mode.

**Note:** All LEDs will turn to amber colour and start blinking, which means it's on Sate mode.

**Waiting for Terminal to reboot into safe mode.**

110

The FBB Web console will appear. Re-log in using the provided username and password.

**Note:** If the FBB BDU web console didn't appear, you can manually re-refresh the web console by clicking the F5 on your keyboard.

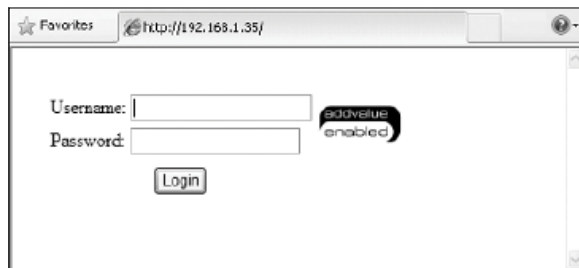

4. Browse to the location of the new firmware, select, and click Upload.
5. Firmware upgrade will take approximately 10 to 12 minutes to complete.
6. You will be prompted with the Result: Firmware Upgrade Completed message.



1. Click **Reboot Terminal** to reboot the FBB BDU.



### Reboot Terminal

If you wish to reboot the FBB BDU, click Reboot Terminal. Click Reboot and wait for a few minutes to allow the TU to reboot. Refresh your browser to update the Web Console page after reboot.

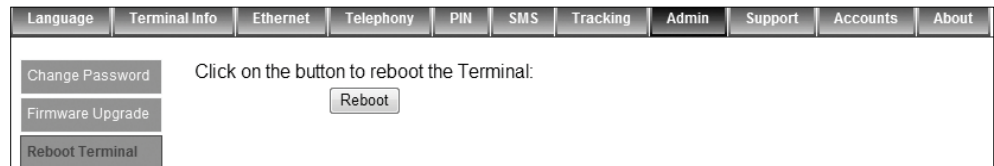

### Factory Reset

To perform a Factory Reset, enter the Security code 0000 and click Factory Reset.

**Warning: All the settings and user data (e.g., Phone Book, GPS, etc.) of the FBB BDU will be cleared and reset to the default settings. If you do not wish to lose critical user data such as Phone Book, please use limited reset option available via Primary Handset.**

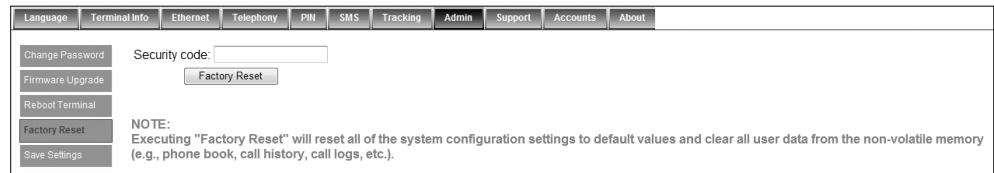

### Save Settings

To power down the FBB BDU Terminal Unit using the main power switch, it is recommended to save the recent setting changes. To save the recent changes, click Save Now.

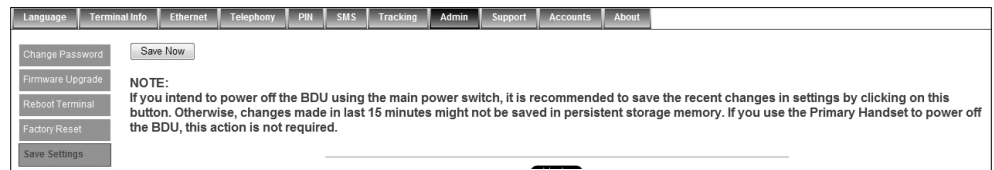

### GPS Output

By default, FBB BDU Transceiver Unit outputs the GPS data in NMEA format (at 9600bps) via the NMEA 0183 Connector for GPS output. For technician who wants to diagnose the system, he/she may collect the debug log messages by selecting Output Debug Log. Since the debug mode is not required for normal users, it is recommended not to make any changes to this setting.

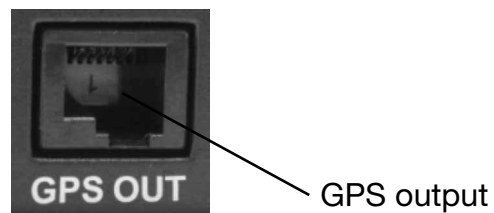

Language	Terminal Info	Ethernet	Telephony	PIN	SMS	Tracking	Admin	Support	Accounts	About
Change Password	<input type="radio"/> Output GPS Data (NMEA @ 9600bps)									
Firmware Upgrade	<input checked="" type="radio"/> Output Debug Log (@ 115200bps)									
Reboot Terminal	<input type="button" value="Update"/>									
Factory Reset										
Save Settings										
GPS Output			<b>addvalue</b> enabled							

### Ciphering

Enabling the Ciphering option will make the FBB BDU to exchange voice and data in secure mode by encrypting them over the air. To enable/disable the Ciphering, select the option Enabled or Disabled respectively and click Update to make the change to take effect.

Language	Terminal Info	Ethernet	Telephony	PIN	SMS	Tracking	Admin	Support	Accounts	About
Change Password	<b>Ciphering:</b> <input type="radio"/> Enabled <input checked="" type="radio"/> Disabled									
Firmware Upgrade	<input type="button" value="Update"/>									
Reboot Terminal										
Factory Reset										
Save Settings										
GPS Output			<b>addvalue</b> enabled							
Ciphering										

### Remote access

By enabling the Remote Access option, user can remotely (from shore) access the terminal's web console via internet. In order to have a remote access, the terminal should be set in Router Mode ( multi-user ) and a PDP context active. If there is no active PDP context, the user can activate the PDP context by means by SMS command.

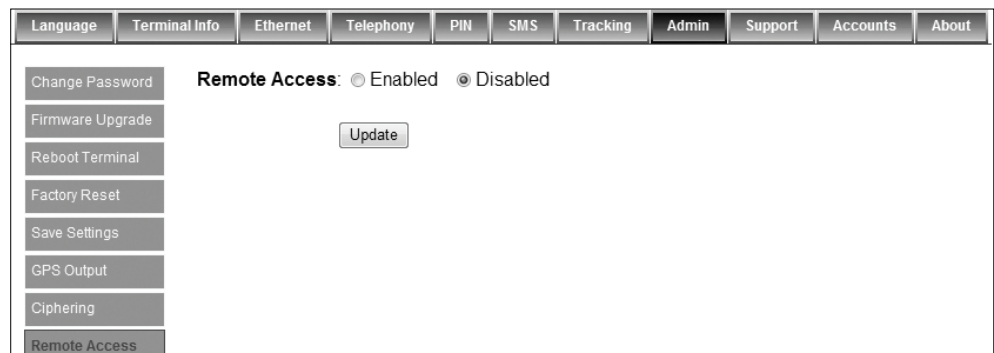

To access the web console remotely, the user has to use the public IP address of the PDP context.



---

## Backup/Restore

If you wish to backup your current settings, you may choose Full backup or Partial Backup:

1. Full backup – This apply only on the same terminal and not for distribution.
2. Partial backup – It allows distribution of certain settings to many terminals of the same Model and Firmware version.

To restore the previous backup settings, you may click on Browse to locate the backup file and restore accordingly.

The screenshot shows a web interface with a navigation menu at the top containing: Language, Terminal Info, Ethernet, Telephony, PIN, SMS, Tracking, Admin, Support, Accounts, and About. On the left side, there is a vertical menu with buttons for: Change Password, Firmware Upgrade, Reboot Terminal, Factory Reset, Save Settings, GPS Output, Clipping, Remote Access, Backup file store, Feature, and Web. The main content area is titled 'Backup:' and contains two radio button options: 'Full backup (can only be restore on the same Terminal)' and 'Partial backup (able to restore on another Terminal of the same Model)'. A 'Backup' button is located below these options. Under the 'Restore:' section, there is a 'Backup package:' label, a 'Choose File' button, the text 'No file chosen', and a 'Restore' button. A large grey rectangular area is present below the 'Restore' button.

### Feature

Displays the Optional Feature for Fax enabled. To activate the Fax feature, activation PIN is required. Please contact your DP for assistance.

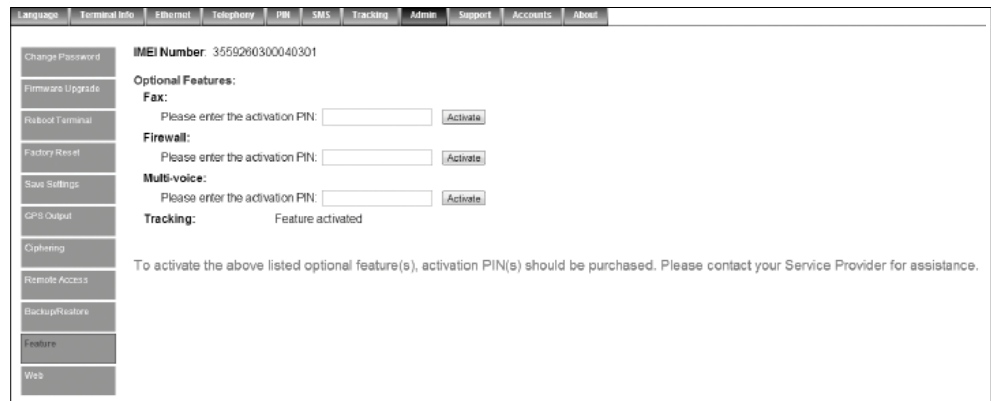

### Web

This tab allows user to configure the web access.

#### - HTTP

For remote access of web console, the user can configure the port number different from the default Port number: 80 if user wants to host a web server on the PC attached to the UT.

#### - HTTP Redirect

When enabled is selected, a warning message will prompt user to activate PDP connection before web browsing.

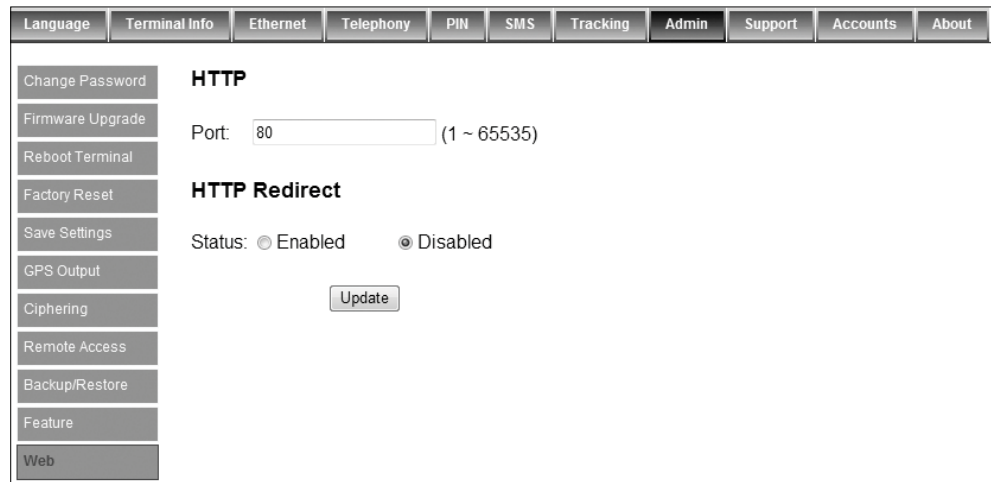



---

## X. Support

Display information of the support telephone number, support email address, Support URL and Services URL. (The information shown is for sample purpose only.)

Language	Terminal Info	Ethernet	Telephony	PIN	SMS	Tracking	Admin	Support	Accounts	About
<b>Inmarsat Distribution Partner Name:</b>		ALPHA TEST DATA								
<b>Phone Number For Support:</b>		+442077281653								
<b>Support E-Mail Address:</b>		BGANTEST1@INMARSAT.COM								
<b>Support URL:</b>		<a href="http://SUPPORT.INMARSAT.COM/MMI1.ASPX">http://SUPPORT.INMARSAT.COM/MMI1.ASPX</a>								
<b>Services URL:</b>		<a href="http://SUPPORT.INMARSAT.COM/MMI2.ASPX">http://SUPPORT.INMARSAT.COM/MMI2.ASPX</a>								

## XI. Accounts

Select Add to add new user.

1. Select **Delete** to delete specific user.
2. Select **Change Password** to change specific user's password.

Language	Terminal Info	Ethernet	Telephony	PIN	SMS	Tracking	Admin	Support	Accounts	About
<b>Accounts</b>		<b>Users: /10</b>								
		<input type="text"/>								
		<input type="button" value="Add"/>								
		<input type="button" value="Delete"/>								
		<input type="button" value="Change Password"/>								

## 9 TROUBLESHOOTING

### General LED status

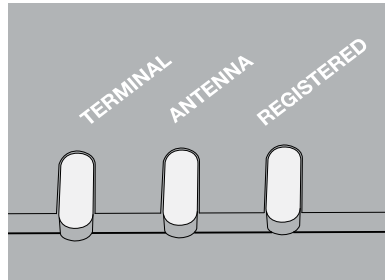

#### BDU LED

LED behavior	Descriptions / Remedial Actions
<b>Off</b>	BDU is in power-off state.
<b>Steady amber</b>	BDU is powering up.
<b>Steady green</b>	BDU successfully powered up.
<b>Steady red</b>	System failure during boot up or operation. User action required.

#### Antenna LED

LED behavior	Descriptions / Remedial Actions
<b>Off</b>	ADU status is unknown.
<b>Steady amber</b>	ADU is powering up.
<b>Blinking amber</b>	ADU is calibrating.
<b>Blinking green</b>	System is searching for satellite.
<b>Steady green</b>	System is locked onto a satellite and ready for use.
<b>Steady red</b>	System failure in ADU. User action required.

#### Network Registered LED

LED behavior	Descriptions / Remedial Actions
<b>Off</b>	System is not registered to the network. Network service is unknown.
<b>Blinking green</b>	Ready for packet data only.
<b>Steady green</b>	Network registration succeeded. Full network service available.
<b>Blinking amber</b>	Ready for voice only.
<b>Steady red</b>	System failure in network registration. User action required.

---

## SIM Card

Symptoms	Descriptions / Remedial Actions
<b>SIM Card cannot be detected BDU</b>	<ul style="list-style-type: none"><li>• Ensure that a correct Inmarsat SIM card is used.</li><li>• Ensure that a SIM card is properly inserted into SIM Card slot.</li><li>• Retry by re-inserting the SIM card into SIM Card Slot before powering up the BDU.</li></ul>
<b>BDU indicates “Wrong SIM Card”</b>	<ul style="list-style-type: none"><li>• Ensure that a correct SIM card is used.</li></ul>

## GPS Output

Symptoms	Descriptions / Remedial Actions
<b>Unable to acquire GPS even after a long time</b>	<ul style="list-style-type: none"><li>• Ensure that there is no blockage for the antenna.</li><li>• Ensure that the antenna cable is secured properly.</li></ul>
<b>No NMEA string output from the GPS output port</b>	<ul style="list-style-type: none"><li>• Ensure that there is a proper connection at the GPS output port.</li><li>• Ensure that the GPS output is set to Output NMEA data via the Web Console.</li></ul>

## PoE LAN Port (RJ45)

Symptoms	Descriptions / Remedial Actions
<b>No LAN indication</b>	<ul style="list-style-type: none"><li>• Ensure that the Ethernet Cable is plugged into the PoE LAN port (RJ45) or the standard LAN port (RJ45) correctly.</li><li>• Check to ensure that the Ethernet Port on your PC / Laptop is working fine.</li></ul>
<b>Unable to acquire IP address. PC shows “Limited connectivity”</b>	<ul style="list-style-type: none"><li>• Try to unplug and reconnect the Ethernet Cable.</li><li>• Try to reboot the BDU.</li><li>• Try to restart your PC/Laptop.</li></ul>
<b>Unable to ping my BDU</b>	<ul style="list-style-type: none"><li>• Ensure that the LAN indication LED is active.</li><li>• Ensure that the IP address of the BDU is set correctly.</li><li>• Make sure that there is no firewall or proxy settings in your PC/laptop that prevent access to the BDU.</li></ul>

RJ11 Phone Port for Standard Call

Symptoms	Descriptions / Remedial Actions
<b>Unable to make outgoing call</b>	<ul style="list-style-type: none"> <li>• Make sure that there is dial tone before making the call. For the case of busy tone,                             <ul style="list-style-type: none"> <li>◦ Ensure that the line is not engaged by any other telephone services.</li> <li>◦ Ensure that all other telephony devices are hung up properly.</li> </ul> </li> <li>• For the case of no dial tone,                             <ul style="list-style-type: none"> <li>◦ Ensure that the phone line is connected to the phone port of the BDU.</li> </ul> </li> <li>• Hang up and retry the call again.</li> </ul>
<b>Unable to receive incoming call</b>	<ul style="list-style-type: none"> <li>• Ensure that the line is not engaged by any other telephony devices.</li> <li>• Ensure that all other telephony devices are hung up properly.</li> <li>• Ensure proper BDU LED states.</li> <li>• Ensure the phone ports are configured correctly.</li> </ul>
<b>Distorted audio during outgoing/ incoming call</b>	<ul style="list-style-type: none"> <li>• The audio may clip when use with some phones in high volume. Please lower the volume of the phone in such situation.</li> <li>• Please temporarily disconnect any data connection since high throughput may affect the quality of the audio.</li> <li>• Hang up and retry the call again.</li> </ul>

Primary Handset

Symptoms	Descriptions / Remedial Actions
<b>No display/power for Primary handset</b>	<ul style="list-style-type: none"> <li>• Check the DC power supply input to the BDU.</li> <li>• Check the primary handset is properly inserted to the handset port.</li> </ul>
<b>Unable to connect to the BDU</b>	<ul style="list-style-type: none"> <li>• Ensure the primary handset is inserted to the handset port.</li> </ul>
<b>Unable to make outgoing call</b>	<ul style="list-style-type: none"> <li>• Ensure a correct number format is being dialed.</li> <li>• Ensure proper BDU LED states.</li> <li>• Hang up and retry to make the call.</li> </ul>
<b>Unable to receive incoming call</b>	<ul style="list-style-type: none"> <li>• Ensure that the line is not engaged by any other telephony devices.</li> <li>• Ensure that all other telephony devices are hung up properly.</li> <li>• Ensure proper BDU LED states.</li> <li>• Ensure the phone ports are configured correctly.</li> </ul>
<b>No audio during incoming/outgoing call</b>	<ul style="list-style-type: none"> <li>• Ensure the Primary Handset connector is inserted into the handset port properly.</li> <li>• Hang up and retry the call again.</li> <li>• Try to reboot the BDU.</li> </ul>
<b>Distorted audio during incoming/ outgoing call</b>	<ul style="list-style-type: none"> <li>• Lower the volume of the Primary Handset.</li> <li>• Please temporarily disconnect any background data connection since high throughput may affect the quality of the audio.</li> <li>• Hang up and retry the call.</li> </ul>

---

## web Console

Symptoms	Descriptions / Remedial Actions
<b>Unable to access Web Console</b>	<ul style="list-style-type: none"><li>• Ensure that there is no problem with the Ethernet connectivity.</li><li>• Ensure that IP address is entered correctly.</li><li>• Try to refresh the browser after correcting the problem.</li></ul>
<b>Unable to login</b>	<ul style="list-style-type: none"><li>• Ensure that correct username and password are used (Password and username are case sensitive).</li><li>• Ensure that you do not open more than the maximum Web Console sessions allowed.</li><li>• Retry by closing and reopening the web browser.</li></ul>
<b>Web page does not seem to be updated or there are unexpected errors occurred.</b>	<ul style="list-style-type: none"><li>• Refresh the web page.</li><li>• Update the web browser to the latest version and retry.</li></ul>

## Data Connection

Symptoms	Descriptions / Remedial Actions
<b>Unable to active Primary PDP context</b>	<ul style="list-style-type: none"><li>• Ensure you are using a valid APN.</li><li>• Ensure that the signal strength is good.</li><li>• Ensure that the PS status icon is highlighted.</li><li>• Ensure your SIM card supports PS services.</li><li>• Ensure your prepaid credit is not exhausted</li></ul>
<b>Unable to access internet after successfully Primary PDP context activation</b>	<ul style="list-style-type: none"><li>• Ensure proper PC/laptop Ethernet settings.</li><li>• Ensure no firewall/proxy settings are preventing access to the BDU.</li><li>• Ensure that the PC/laptop is configured to obtain IP address automatically (DHCP) or with static IP address in the range: 192.168.0.1 - 192.168.254.254</li></ul>
<b>“Always On” feature is not working</b>	<ul style="list-style-type: none"><li>• Ensure feature is enabled via Web Console.</li><li>• A standard background connection has to be manually activated for the first time after enabling this feature.</li></ul>

## Data Connection

Symptoms	Descriptions / Remedial Actions
<b>Unable to enter safe mode. BDU continues to start in normal mode.</b>	<ul style="list-style-type: none"><li>• Make sure that the safe mode button (the button besides the SIM card slot) is pressed and held securely until all LEDs turn into amber colour.</li></ul>
<b>Firmware upgrade fails</b>	<ul style="list-style-type: none"><li>• Make sure that you are using the correct firmware upgrade package.</li><li>• Make sure that there is no interruption of power supply during firmware upgrade.</li><li>• Retry firmware upgrade.</li></ul>

Antenna / Satellite Signal Level

Symptoms	Descriptions / Remedial Actions
<b>Low Signal Strength</b>	<ul style="list-style-type: none"> <li>• Check any obstruction such as the hull or monkey bridge of the vessel that may block the ADU's line of sight.</li> <li>• Check any interference signal from other electronics devices that are close to the ADU</li> <li>• Check to ensure that the antenna cable is properly secured.</li> <li>• Depending on the antenna's location on the vessel, the vessel's route may cause the ADU's line of sight to be blocked by any structure of the vessel, depending on the elevation of the satellite.</li> </ul>

System fails to power up

Symptoms	Descriptions / Remedial Actions
<b>No light appear on BDU LED.</b>	<ul style="list-style-type: none"> <li>• Ensure the power switch on the front panel is at "On" position.</li> <li>• To reset the circuit breaker on the front panel by depressing the lever of the circuit breaker inward fully and release.</li> <li>• Check to ensure that the input DC power will have at least +24VDC, 10A or +12VDC, 20A.</li> </ul>

---

## Warranty

This product is warranted by Intellian Technologies Inc., to be free from defects in materials and workmanship for a period of Three (3) YEARS on parts and ONE (1) YEAR on labor performed at Intellian Technologies, Inc. service center from the purchased date of the product.

Intellian Technologies, Inc. warranty does not apply to product that has been damaged and subjected to accident, abuse, mis-use, non-authorized modification, incorrect and/ or non-authorized service, or to a product on which the serial number has been altered, mutilated or removed.

It is required to present a copy of the purchase receipt issued by the re seller. that indicates the date of purchase for after-sales service under the warranty period. In case of failure to present the purchase receipt, the warranty period will begin 30 days after the manufacturing production date of the product purchased.

Any product which is proven to be defective in materials or workmanship, Intellian Technologies, Inc. will (at its sole option) repair or replace during the warranty period in accordance with this warranty. All products returned to Intellian Technologies, Inc. under the warranty period must be accompanied by a return material authorization (RMA) number issued by the dealer/distributor from Intellian Technologies, Inc. and a copy of the purchase receipt as a proof of purchased date, prior to shipment. Alternatively, you may bring the product to an authorized Intellian Technologies, Inc. dealer/distributor for repair.

## Technical Specification

Model	Specifications
Intellian FB250/500	Fleetbroadband Terminal
Dimension and Weight	
ADU	FB250: 17.3 x 16.9 in (44 x 43cm) / 9 lbs (4.1kg) FB500: 28.3 x 27.6 in (72cm x 70cm) / 34.1 lbs (15.5kg)
BDU	14.1 x 9.8 x 2.6 in (36 x 25 x 6.7 cm) / 8.5 lbs (3.9 kg)
Handset	5.5 x 2.2 x 0.8 in (14.2 x 5.6 x 2.2 cm) / 0.8 lbs (0.39 kg)
Environmental Conditions	
Operating Temperature	-13° F to+131° F(-25° Cto+55° C)
Operating Humidity	[ADU]EN60945,[BDU]95%non-condensingat+40° C
Water Ingress	[ADU] IP56, [BDU] IP31
Approvals	Inmarsat FleetBroadband/ RTTE/ CE/ FCC
Warranty	3 Years Parts and 1 Year Labor
Global Services	
Voice	Digital 4 kbps Voice
Standard IP	FB250: Up to 150 kbps FB500: Up to 432 kbps
SMS	Up to 160 characters (3G standard)
FAX	Group 3 (via 3.1KHz Audio)
Airtime Service	Inmarsat airtime
Frequency Band	
Rx	1518.0 MHz – 1559.0 MHz
Tx	1626.5 MHz – 1675.0 MHz
Ch. Width	[Rx] 10.5 - 189 kHz, [Tx] 21 - 189 kHz
Power Supply and Consumption	
DC Input Range	10 - 32V DC (isolated)
Power (max)	150W @ 10-32V (including antenna)



---

# Intellian®

---

## APAC

### Headquarters

Intellian Technologies, Inc.  
348-5 Chungno-Ri, Jinwi-Myeon  
Pyeongtaek-Si, Gyeonggi-Do 451-862 Korea  
T +82 31 379 1000 F +82 31 377 6185

Tech Support: [SupportAPAC@intelliantech.com](mailto:SupportAPAC@intelliantech.com)

---

### Seoul Office

Intellian Technologies, Inc.  
2F Donggik Building, 98 Nonhyun-Dong  
Gangnam-Gu, Seoul 135-010 Korea  
T +82 2 511 2244 F +82 2 511 2235

---

## Americas

### Irvine Office

Intellian Technologies USA, Inc.  
9004 Research Drive  
Irvine, CA 92618 USA  
T 949 727 4498 F 949 271 4183

Tech Support: [SupportAMERICAS@intelliantech.com](mailto:SupportAMERICAS@intelliantech.com)

---

## EMEA

### Rotterdam Office

Intellian B.V.  
Bristolstraat 1, 3047AB  
Rotterdam, The Netherlands  
T +31 1 0820 8655 F +31 1 0820 8656

Tech Support: [SupportEMEA@intelliantech.com](mailto:SupportEMEA@intelliantech.com)

---

### UK Office

Intellian Ltd.  
Epsilon House, Enterprise Road, Southampton Science Park,  
Southampton, Hampshire SO16 7NS, United Kingdom  
T +44 2380 019 021 F +44 2380 767 092

---

## Maritime Technical Center

### Busan Office

Intellian Technologies, Inc.  
#906 Ace High Tech 21, 1470 Woo-Dong  
Haeundae-Gu, Busan 612-020 Korea  
T +82 51 746 9695 F +82 51 746 9440

---

[info@intelliantech.com](mailto:info@intelliantech.com)

[www.intelliantech.com](http://www.intelliantech.com)