

IBUC 1:1 Protection System

Advantages

1:1 switching logic and drivers reside in the IBUCs - no external logic controller required.

Supports IBUC's with AC power input or separate DC power supplies.

Web browser interface with embedded web pages for easy setup, monitor, and control.

Auto-Cloning function means user sets up primary IBUC as desired and secondary unit clones its settings.

LEDs provide quick visual indication of IBUC condition.

Compact, integrated mounting package.

Separate outdoor RX 1:1 system available in AC-powered version or operating with DC power from IBUC power supplies.

Access via:

- FSK through TX IFL cable.
- TCP/IP with embedded web pages.
- SNMP agent
- RS485/232 serial port.
- Handheld Terminal.

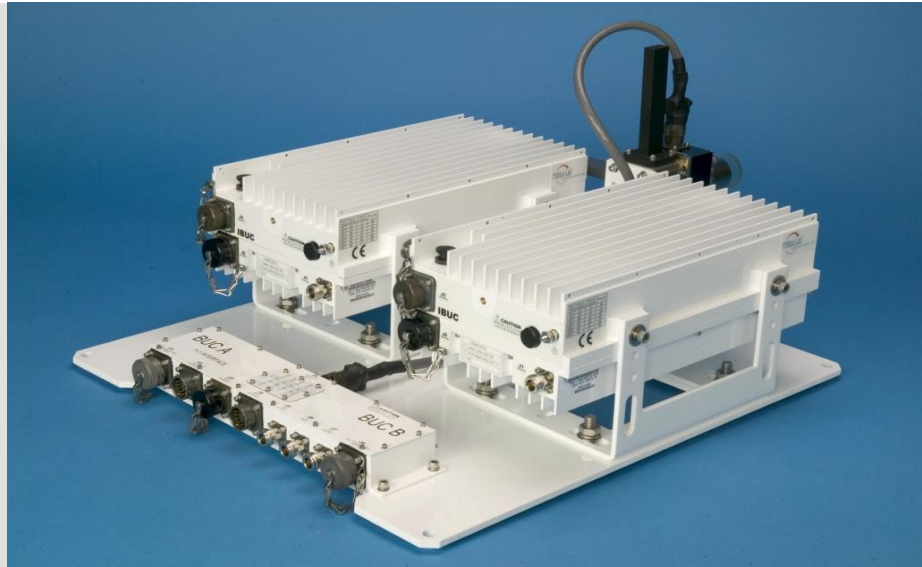

The IBUC redefines 1:1 protection switching. Instead of using a separate switching logic unit with its expense and complexity, Terrasat incorporates the switching logic and drivers into the IBUC itself.

Protected units monitor each other's alarm condition and, through a simple switching junction box, make the decision to switch. The IBUC 1:1 package includes a cloning feature to simplify 1:1 setup. Terrasat's 1:1 solution is a complete package with a dual-IBUC mounting bracket for convenient installation.

A 1:1 junction box mounts on the 1:1 mounting plate. Practically a passive unit, the junction box manages the functions of dividing the IF signal and routing signals through an Ethernet switch. It supports interface connectors and includes a bank of LEDs for visual indication of alarm conditions. The user interface is via web browser to embedded web pages, handheld terminal, RS232 or RS485.

A Receive 1:1 system is available with a separate outdoor RX interface box. The receive interface box performs all required functions for 1:1 operation of LNB's. The RX 1:1 can receive DC power from the IBUC power supplies or it can be powered by direct AC input. No indoor controller is necessary. Monitoring and control is via TCP/IP port on the interface box. The interface box fits the Terrasat universal mounting bracket and the system comes with cables and waveguide switch.

IBUC 1:1 Protection System

System Losses

10 MHz at 0 dBm	< 4 dB
FSK at 0 dBm	< 5 dB
L-band at 0 dBm	< 5 dB

Operating Temperature: -40°C to +60°C

Interconnecting cables included

Waveguide Switch included

Systems ship assembled and pre-tested

Monitor and Control

Ethernet (HTTP, Telnet, SNMP)

RS232/485, Hand-held Terminal via MS-type connector

FSK, multiplexed on TX IFL.

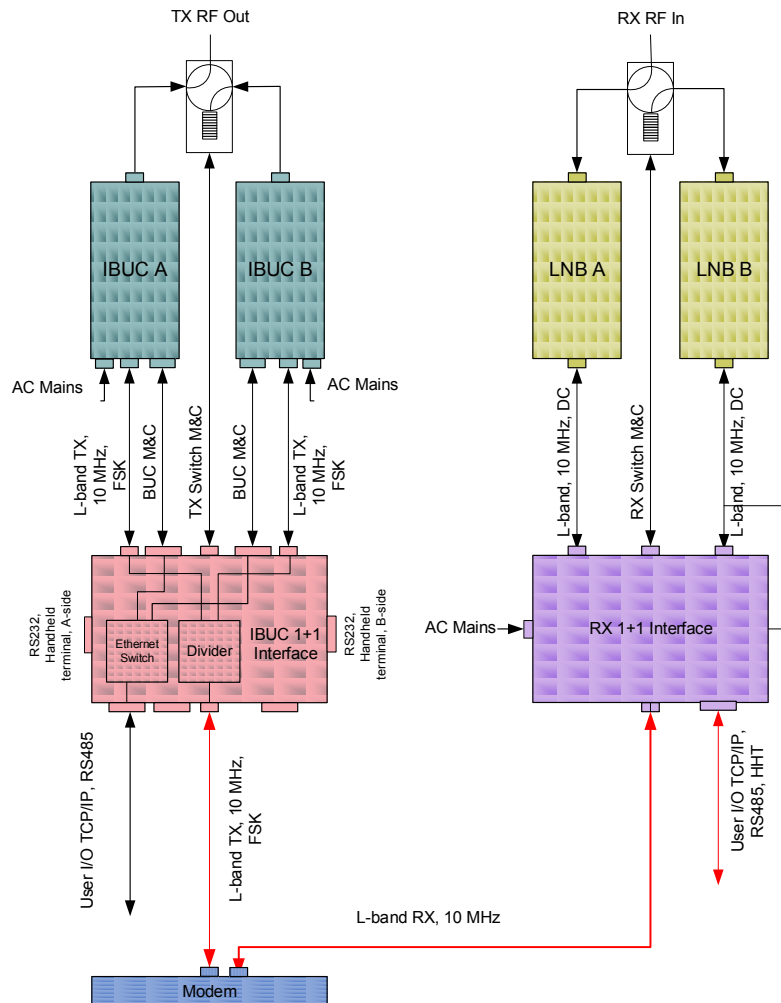

Specifications are subject to change without notice

1:1 System Data Sheet 2/1/14